



NATIONAL POLAR-ORBITING OPERATIONAL ENVIRONMENTAL SATELLITE SYSTEM (NPOESS)

**NPOESS Common Data Format Control Book -
External Volume VII – Part I – NPOESS Downlink Data Formats
D34862-07-01 Rev A**

CDRL No. A014

**Northrop Grumman Space & Mission Systems Corporation
One Space Park
Redondo Beach, California 90278**

**Copyright © 2004-2009
Northrop Grumman Corporation and Raytheon Company
Unpublished Work
ALL RIGHTS RESERVED**

Portions of this work are the copyrighted work of Northrop Grumman and Raytheon. However, other entities may own copyrights in this work.

This documentation/technical data was developed pursuant to Contract Number F04701-02-C-0502 with the US Government. The US Government's rights in and to this copyrighted data are as specified in DFAR 252.227-7013, which was made part of the above contract.

This document has been identified per the NPOESS Common Data Format Control Book – External Volume 5 Metadata, D34862-05, Appendix B as a document to be provided to the NOAA Comprehensive Large Array-data Stewardship System (CLASS) via the delivery of NPOESS Document Release Packages to CLASS.

The information provided herein does not contain technical data as defined in the International Traffic in Arms Regulations (ITAR) 22 CFR 120.10.
This document has been approved by the United States Government for public release in accordance with NOAA NPOESS Integrated Program Office.

Distribution: Statement A: Approved for public release; distribution is unlimited.



NATIONAL POLAR-ORBITING OPERATIONAL ENVIRONMENTAL SATELLITE SYSTEM (NPOESS)

NPOESS Common Data Format Control Book - External Volume VII – Part I – NPOESS Downlink Data Formats D34862-07-01 Rev A

CDRL No. A014

PREPARED BY:

Teri Marfizo, System Engineering IPT

ELECTRONIC APPROVAL SIGNATURES:

Clark Snodgrass, SEITO Director

Fabrizio Pela, SE&I IPT Lead

Keith Reinke, Ground Segments IPT Lead

Mary Ann Chory, Space Segment IPT Lead

Ben James, Operations and Support IPT Lead

David Rosener, NPOESS Program Manager



Revision/Change Record

Document No. D34862-07-01

Revision	Document Date	Revision/Change Description	Pages Affected
---	07/03/08	Initial Release, supersedes D34862-07, revision A. ECR 790A Incorporates ECR 747A, Rev D Update to NPOESS Data Mapping. Incorporates ECR 802G, Key Management OpsCon Scenario Rev C and Requirements Updates	All
A	01/30/09	ECR 901D – Revision A Adds VIIRS Auxiliary Processor (VAP) processing information and formats for VIIRS HRD and LRD science data Adds background sensor information for VIIRS, ATMS, CrIS and OMPS. Adds extensive discussion of packet processing for VIIRS HRD Science Data, HRD Calibration Data and HRD Diagnostic Data. Adds extensive discussion of packet processing for CrIS Earth Scene Data. Adds extensive discussion of packet processing for OMPS NTC Earth View, NPR and NTCC Data Add new APIDs and description of priority packets and segmented packetization for Mission Support Data. Adds some content for Spacecraft Auxiliary Data containing attitude and ephemeris	All

Table of Contents

1.0	INTRODUCTION.....	1
1.1	Document Purpose and Scope	1
1.2	Document Overview.....	1
1.3	Nomenclature.....	3
1.4	Bit Numbering and Bit Significance Convention.....	3
1.5	Mission Data Repository (MDR) Definition.....	4
1.5.1	MDR Coding Standards	4
1.5.2	MDR Versioning and Configuration Management.....	4
1.5.3	MDR Schema	4
1.5.4	MDR Data Dictionary	5
2.0	NPOESS DOWNLINK DATA STRUCTURES	14
2.1	Application Packet	16
2.1.1	Application Packet Structure	16
2.1.2	Application Packet Field Contents	19
2.2	Multiplexing Protocol Data Unit.....	22
2.2.1	MPDU Header Field Contents	22
2.2.2	MPDU Packet Zone Field Contents	23
2.3	Coded Virtual Channel Data Unit.....	24
2.3.1	CVCDU Primary Header – Field Contents	25
2.3.2	CVCDU Insert Zone – Field Contents	25
2.3.3	CVCDU Data Zone Contents	26
2.3.4	Reed Solomon Codeblock Segment Contents.....	26
2.4	Channel Access Data Unit	27
2.4.1	CADU Structural Elements	27
2.4.2	CADU Encoding.....	28
2.5	Fill CADU	29
2.6	Marker Block CADU.....	30
3.0	NPOESS SPACECRAFT BUS	33
3.1	Spacecraft SCP Auxiliary Data	34
3.2	Spacecraft DSU Auxiliary Data	36
4.0	SENSOR DATA.....	37
4.1	Visible/Infrared Imager Radiometer Suite	37
4.1.1	VIIRS Instrument Overview.....	37
4.1.2	High Rate Data (HRD) - Science	48
4.1.3	High Rate Data (HRD) - Calibration	72
4.1.4	Engineering.....	79
4.1.5	Low Rate Data (LRD) - Science.....	81
4.1.6	HRD – Diagnostic Calibration	91
4.1.7	High Rate Data (HRD) - Diagnostic	92
4.1.8	Health and Status and Diagnostic Dwell Telemetry	100
4.1.9	Memory Dump	101
4.2	Advanced Technology Microwave Sounder.....	103
4.2.1	ATMS Data Collection Modes and Packet Processing	107
4.2.2	Command Status	114

4.2.3	Engineering – Launch, Early Orbit & Anomaly	115
4.2.4	Calibration.....	116
4.2.5	Diagnostic.....	117
4.2.6	Dwell	118
4.2.7	Engineering – Housekeeping	119
4.2.8	Memory Dump	120
4.2.9	Science – Operational Mode.....	122
4.2.10	Engineering – Hot Calibration Temperatures.....	123
4.2.11	Engineering – Health and Status	124
4.2.12	Science – Diagnostic Mode	125
4.2.13	Hardware Error Status	126
4.3	Cross Track Infrared Sounder.....	127
4.3.1	CrIS Instrument Modes and Packet Processing	133
4.3.2	Science – Earth, Deep Space & Internal Calibration Scenes.....	139
4.3.3	Science Telemetry	143
4.3.4	Engineering Telemetry.....	144
4.3.5	Low Rate Data	145
4.3.6	Housekeeping Dwell	146
4.3.7	Scene Selection Mirror (SSM) Dwell.....	147
4.3.8	Interferometer Dwell	148
4.3.9	Diagnostic.....	149
4.3.10	Memory Dump	151
4.3.11	Instrument HK Telemetry Sub-Packet.....	153
4.3.12	Launch and Early Orbit Packet	154
4.4	Ozone Mapping and Profile Suite	155
4.4.1	Instrument Overview	155
4.4.2	Modes and Packet Processing	156
4.4.3	Dwell.....	164
4.4.4	FSW Bootup	166
4.4.5	Table/Memory Dump	167
4.4.6	Science – Nadir Total Column Earth View	168
4.4.7	Science - NPR	174
4.4.8	Calibration – NTCC.....	177
4.4.9	Calibration – NPC	179
4.4.10	Health & Status Data	181
4.4.11	LEO & A Housekeeping Data	182
4.4.12	Test Telemetry.....	183
4.5	Clouds and the Earth’s Radiant Energy System (EDFCB7-TBR-10299).....	184
4.6	Microwave Imager Sounder	185
4.7	Space Environment Monitor.....	186
4.8	Space Environment Sensor Suite	187
4.9	Advanced Data Collection System.....	188
4.9.1	A-DCS Overview.....	188
4.9.2	Housekeeping.....	191
4.9.3	Science – SMD	193
4.10	Search and Rescue Satellite Aided Tracking.....	194

4.10.1	SARSAT System Overview.....	194
4.10.2	Telemetry – SARR and SARP	198
5.0	MISSION SUPPORT DATA	200
5.1	Ancillary Data – Geographic Distribution	202
5.2	MSD – Global Distribution.....	204
5.3	Auxiliary Data – Two Line Element (TLE) Sets	205
5.4	Direct Mode Data Message.....	206
5.4.1	Uplink and Downlink Packetization	206
5.5	AES2 Key Transports	208
5.5.1	Uplink and Downlink Packetization	209
5.6	Digital Signature Key Transport	211
5.6.1	Uplink and Downlink Packetization	212
5.7	Key Agreement Key Transport.....	213
5.7.1	Uplink and Downlink Packetization	214
	APPENDIX A: DATA MNEMONIC TO INTERFACE MAPPING.....	215
	APPENDIX B: DOCUMENT SPECIFIC ACRONYM LIST	230
	APPENDIX C: MDR SCHEMA	233
	APPENDIX C: XML STYLE SHEET	251

List of Figures

Figure 1.5-1, Bit Numbering and Significance Convention	3
Figure 1.5.3-1, MDR Structure	5
Figure 2.0-1 NPOESS External Downlink Data Structures	15
Figure 2.1.1.3-1, Packet Sequence Structure	18
Figure 2.6-1, Block Structure of SMD Partition on SSR	31
Figure 2.6-2, Marker CADU Structure	31
Figure 2.6-3, Marker Packet Field Contents	32
Figure 4.1.1-1, VIIRS Simplified Design Concept	37
Figure 4.1.1-2, VIIRS ANTI-Solar/Travel-Direction Sides & OMM Interface Mounts	38
Figure 4.1.1.1-1, VIIRS Subsystem Overview with 2-alpha Ids	41
Figure 4.1.1.2-1, VIIRS Mode Transitions	43
Figure 4.1.2-1, First Packet (metadata) in VIIRS Segmented Packet	51
Figure 4.1.2-2, Middle Packet in VIIRS Segmented Packet	52
Figure 4.1.2-3, VIIRS Scanning Geometry for Science Data	56
Figure 4.1.2-4, VIIRS Overview of Science Data Processing in Operational Mode	58
Figure 4.1.2.1-1, VIIRS Aggregation for Single Gain/Imaging HRD – Operational Mode	59
Figure 4.1.2.1-2, VIIRS Overview of Aggregation Zone Definition	59
Figure 4.1.2.2-1, Bow-tie Deletion for Moderate Resolution Bands	60
Figure 4.1.2.2-1, Bow-tie Deletion for Imagery bands	60
Figure 4.1.2.3-1, VIIRS Band Reconstruction Diagram	64
Figure 4.1.2.3-2, VIIRS Reconstruction of Imaging Bands with Moderate Resolution Bands as Predictors	65
Figure 4.1.2.4-1, VIIRS Piecewise Linear Function Resulting From Dual Gain Processing	67
Figure 4.1.2.5-2, VIIRS Flow for Extraction of Operational Mode Data from Science Data	68
Figure 4.1.2.6-1, VIIRS Packet Structure & Definition of terms for DNB – Operational Mode	70
Figure 4.1.2.6-2, VIIRS DNB Processing Flow – Operational Mode	71
Figure 4.1.3-1, VIIRS Format of Detector Data Field in Calibration Packet – Diagnostic Mode	73
Figure 4.1.3-2, VIIRS Calibration Data Packet Structure	74
Figure 4.1.3-3, VIIRS Format of Detector Field in Calibration Packet – Operational Mode	74
Figure 4.1.3-4, VIIRS Format of Detector Data Field in Calibration Packet – Diagnostic Mode	75
Figure 4.1.3-5, VIIRS Calibration Data Packet Processing – Operational Mode	76
Figure 4.1.3-6, VIIRS Calibration Data Packet Processing – Diagnostic Mode	76
Figure 4.1.5.1-1, VAPS Processing Overview	83
Figure 4.1.5.1-2, Data flow description between SBC/RDD.	84
Figure 4.1.5.1-2, Data Flow Description between SBC/RDD	84
Figure 4.1.5.1-3, First Packet Format of the LRD Segmented Packet	88
Figure 4.1.5.1-4, Middle/ Last Packets Format of LRD Segmented Packet with 12-bit Pixels	89
Figure 4.1.7-1, VIIRS Overview of Science Data Processing in Diagnostic Mode	93
Figure 4.1.7-2, VIIRS Overview of Data Handling in Diagnostic Mode	94
Figure 4.1.7.2-1, VIIRS Science Data Processing Overview – Diagnostic Mode	96
Figure 4.1.7.3-1, VIIRS Format of DNB Data when in Diagnostic Mode	97
Figure 4.1.7.3-2, VIIRS DNB Processing Flow – Diagnostic Mode	99
Figure 4.2-1, ATMS Block Diagram	104
Figure 4.2-1 ATMS Redundancies	106
Figure 4.2-3, ATMS Operational Scan Pattern	107
Figure 4.3-1, CrIS Drawing of the Instrument	127
Figure 4.3-2, CrIS Field of Regard About Nadir and 9 Field of Views	128
Figure 4.3-3, CrIS Signal Radiance Flow to Detectors	129
Figure 4.3-4, CrIS Modules (Exploded View)	130
Figure 4.3-5, CrIS Scene View: 30 Steps per 8 Second Scan	130

Figure 4.3-6, CrIS Functional Flow of Space Processing	133
Figure 4.3.1-1, CrIS Modes and Transitions	134
Figure 4.3.1-2, CrIS Normal Cross-track Scan Sequence (Timing in seconds).....	138
Figure 4.2.2-1, OMPS Modes and Mode Transitions.....	158
Figure 4.4.2.4-1, OMPS Time Marker Description for a Descending Orbit.....	160
Figure 4.4.6-1, OMPS CCD Block Diagram	170
Figure 4.4.6-2, OMPS Total Column On-Orbit Windowing and Spatial Binning	173
Figure 4.4.7-1, OMPS Nadir Profile On-orbit Windowing and Spatial Binning.....	176
Figure 5.5-1, AES2 Transports Downlink Format	210

List of Tables

Table 1.5.3-1, MDR Format	7
Table 2.1.1-1, NPOESS Application Packet Structure.....	17
Table 2.1.1.1-1, Application Packet Lengths	17
Table 2.1.1.2-1, Standalone Application Packet Structure	18
Table 2.1.1.3.1-1, Packet Sequence - First Packet Structure.....	19
Table 2.1.1.3.2-1, Packet Sequence - Continuation and Last Packet Structure.....	19
Table 2.1.2.1-1, Application Packet Primary Header - Field Contents.....	20
Table 2.1.2.2.1-1, Standalone AP Secondary Header - Field Contents	20
Table 2.1.2.2.2-1, Packet Sequence AP Secondary Header - Field Contents	21
Table 2.1.2.3-1, AP Application Data- Field Contents	21
Table 2.2-1, MPDU Structure.....	22
Table 2.2.1-1, MPDU Header - Field Contents	22
Table 2.2.2-1, MPDU Packet Zone - Field Contents.....	23
Table 2.3-1, CVCDU Structure	24
Table 2.3.1-1, CVCDU Primary Header - Field Contents	25
Table 2.3.2-1, CVCDU Insert Zone - Field Contents	25
Table 2.4.1-1, CADU Structure	27
Table 4.1.1-1, VIIRS EDRs	39
Table 4.1.1.1-1, VIIRS 2-Alpha Subsystem IDs.....	40
Table 4.1.1.3-1, VIIRS Application Packet Types	47
Table 4.1.2-1, VIIRS Science Data Packet Band Information.....	53
Table 4.1.2-2, VIIRS Gain, Detector, & Bit Summary for Science Data.....	55
Table 4.1.2.3-2, VIIRS Processing Summary for Differential Encoding.....	62
Table 4.1.2.3-3, VIIRS USES Compression Information	63
Table 4.1.3-1, VIIRS Gain, Detector, & Bit Summary for Calibration Data	77
Table 4.1.5.1-1, Data Transfer Structure from SBC to RDD Module	85
Table 4.1.5.1-2, Tile Format for LRD Packets.	86
Table 4.1.7-1, VIIRS Arithmetic Processing Summary	93
Table 4.1.7-2, VIIRS Summary of Number of Samples in Aggregation Zone by Band Type.....	95
Table 4.1.7.3-1, VIIRS DNB Reference Information	97
Table 5.2.4-1, VIIRS Memory Dump User Data Field Contents.....	101
Table 4.2-1, ATMS Redundancy Configurations	106
Table 4.2.1.3-1, ATMS Application Packet Types	110
Table 4.2.1.3-2, ATMS PRT Parameters	112
Table 4.3.1 CrIS Spectral Band Coverage and Resolution.....	131
Table 4.3.1.7-1, CrIS Application Packet Types	137
Table 4.3.2.1-1 CrIS Operational Interferogram Samples by IR Band.....	141
Table 4.2.3.1-2, CrIS Default Bit Trimming Output	141
Table 4.4.2.8-1, OMPS Application Packet Types.....	162
Table 4.2.8-2, OMPS Header Example	163
Table 4.4.6-1, OMPS Timestamp Offset.....	171
Table 4.9.1.2-1, A-DCS Application Packet Types	190
Table 4.10.1.4-1, SARSAT Data Type Mapping and Attributes.....	197
Table 5.0-1, MSD Application Packet Types	201
Table A-1, Data Mnemonic to Interface Mapping	215
Table B-1, Document-Specific Acronym List	230

1.0 INTRODUCTION

1.1 Document Purpose and Scope

Volume VII of the Common Data Format Control Book – External (CDFCB-X) describes the data formats of the externally-delivered NPOESS application packets (APs) from the high-rate data (HRD), low-rate data (LRD) and the stored mission data (SMD) downlink streams. This volume also contains specifications for the NPOESS downlink protocol structures. These formats are provided to support internal and external users in reading and processing of the application packet data contained in Raw Data Records (RDRs), and to facilitate AP decommutation and engineering unit conversion at NPOESS Field Terminals. NPP spacecraft application packet (AP) formats are not documented herein, but can be found in the NPP Mission Data Format and Control Book (MDFCB), document number GSFC 429-05-02-42, and the NPP Command and Telemetry Handbook, document number 568423. For overview information and the reference documents for the entire CDFCB-X, see the CDFCB-X Volume I - Overview, D34862-01.

1.2 Document Overview

For ease of reading, understanding, and use of this document, this volume has been separated into several parts. Each part is distinct in that it does not duplicate information. This is done because the parts together make up the content of the CDFCB-X Volume VII; no part is intended to be standalone.

The parts of this volume are organized in the following manner:

Part 1: NPOESS Downlink Data Formats - Provides the NPOESS generic downlink data structures as well as AP descriptive information for specific sensors

Part 2: NPOESS Downlink Data Formats - CrIS - Contains the formats of APs for the CrIS sensor in an eXtensible Markup Language (XML) and Mathematic Markup Language (MathML) formatted document

Part 3: NPOESS Downlink Data Formats - OMPS - Contains the formats of APs for

the OMPS sensor in an XML and MathML formatted document

Part 4: NPOESS Downlink Data Formats - ATMS - Contains the formats of APs for the ATMS sensor in an XML and MathML formatted document

Part 5: NPOESS Downlink Data Formats - VIIRS - Contains the formats of APs for the VIIRS sensor in an XML and MathML formatted document

The sections of Part 1 are organized in the following manner:

Section 1 Introduction – Provides a brief overview of the document’s purpose, scope, and contents. This section also provides definitions of the Parts II - V AP format database structure and the encoding.

Section 2 External NPOESS Downlink Data Structures – Provides the NPOESS downlink protocol structure specifications for externally-accessed downlink data streams including the high-rate data (HRD), low rate data (LRD), and stored mission data (SMD) streams. The S-Band downlink protocol structure is described in the Internal Data Format Control Book Volume II – Uplink and Downlink Data Transport Formats, D36953-02.

The following sections, 3 through 5, provide AP descriptions for each packet type.

Section 3 NPOESS Spacecraft Bus

Section 4 Sensor Data

Section 5 Mission Support Data (MSD) - These application packets include ancillary data, auxiliary data, direct mode data messages, and Public Key Infrastructure (PKI) Key packets.

1.3 Nomenclature

Downlink packet nomenclature used in program and standards documentation including the terms:

- Version 1 source packet
- CCSDS path protocol data unit
- Application packet

are standardized herein as “application packet” referring to all types of downlink packets. Packet sequence nomenclature used in the NPOESS program including the terms:

- grouped packets
- multi-segmented packet sequence
- Segmented Packet

are standardized herein as “packet sequence”. Words are 16-bits in length unless otherwise noted.

1.4 Bit Numbering and Bit Significance Convention

The first bit transmitted is the most significant bit, and is designated bit 0 in an N-bit data field. Bits are then sequentially numbered up to the least significant bit designated as bit N-1. See Figure 1.5-1, Bit Numbering and Significance Convention.

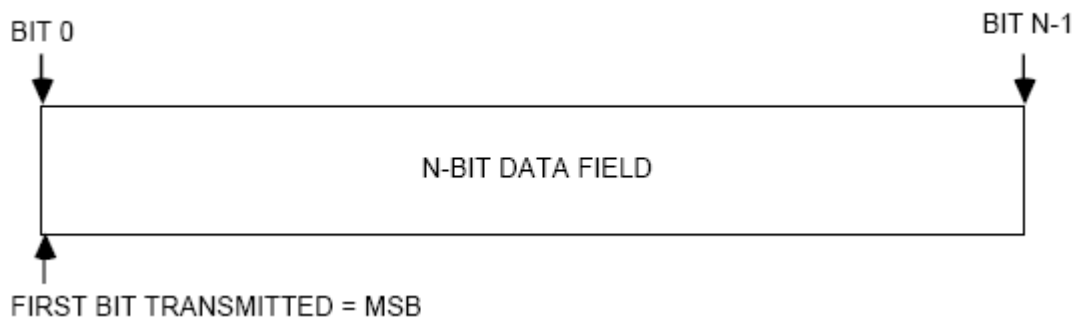

Figure 1.5-1, Bit Numbering and Significance Convention

Structure and field contents tables herein are structured with increasing significance toward the top.

1.5 Mission Data Repository (MDR) Definition

NPOESS application packet formats are described in Parts 2-5 of this document. These AP format descriptions are structured in an ASCII-coded XML and MathML computer file format. The structure of the database and its associated schema are described in the following subsections.

1.5.1 MDR Coding Standards

The MDR character set coding is 8-bit UCS/Unicode Transformation Format (UTF-8). The MDR encoding used to structure the AP format information is XML version 1.0. The standard used to specify the raw to engineering unit conversion equations is content style MathML version 2.0. Both the XML and MathML are open standards defined and supported by the World Wide Web Consortium on their website: <http://www.w3.org/>.

1.5.2 MDR Versioning and Configuration Management

The schema of the MDR contains two required complex elements. These must be included in the XML database to describe and identify the release version. The element names are TITLE_PAGE and RCR_PAGE. As their names imply, these elements are used in an XML format to provide the same information that would be shown on the title page and Revision/Change Record (RCR) pages of a conventional engineering released document.

1.5.3 MDR Schema

The structure of the database is defined and constrained by an XML schema to provide a specific structure that is computer software accessible via open source libraries and also to provide human readability with XML editors or software tools.

The MDR schema is a detailed definition of the MDR structure. It gives users the structural definition of the data that is needed to develop software applications that can access and use the AP format specifications. As with the MDR, the schema is character coded in UTF-8. The MDR schema provides a method of validating that MDR files are compliant.

The MDR schema is provided in Appendix C.

1.5.4 MDR Data Dictionary

The structure of the database is shown in figure 1.5.3-1, MDR Structure. Note that where a number is present, this means the specification requires that number of elements to be present. Otherwise 0 to unbounded elements may be present. The key elements of the MDR database are defined in the schema and explained in Table 1.5.3-1, MDR Format.

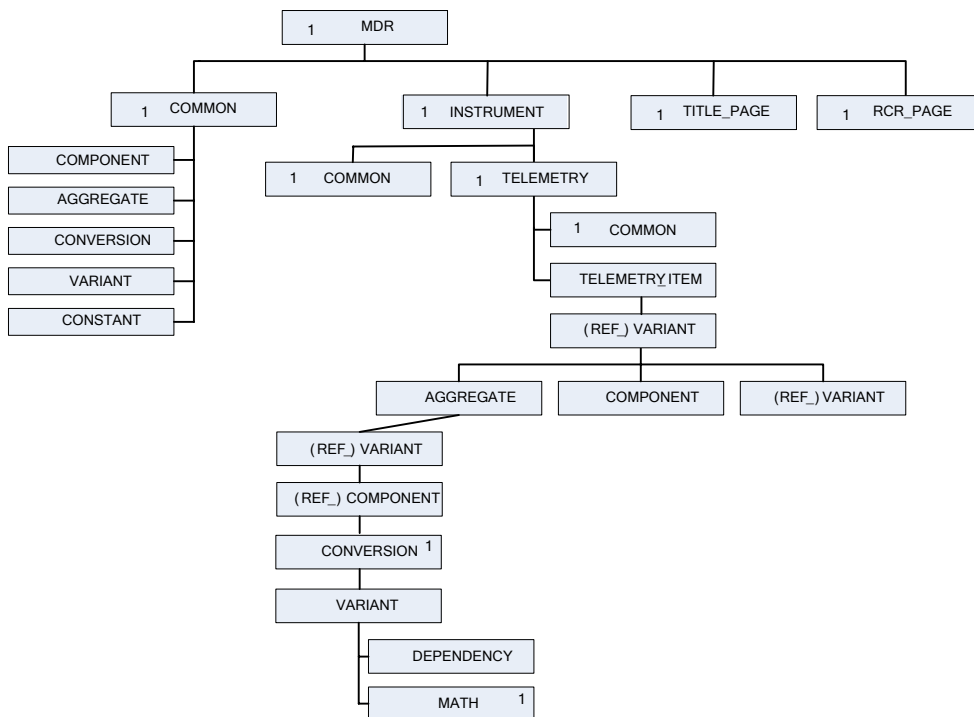

Figure 1.5.3-1, MDR Structure

The first COMMON element under the MDR element specifies common components that are reusable across the entire MDR specification. Similarly, the COMMON element under TELEMETRY specifies components that can be reused by any of the TELEMETRY components. Hence common components can be multiply-referenced for repeated use in multiple packet types. An example of a common component is the group of elements that comprise a primary or secondary header.

Any place that a COMPONENT or VARIANT appears in the specification may instead use the REF_COMPONENT or REF_VARIANT element (except under COMMON) to reference either a COMPONENT or VARIANT defined in a COMMON element that is higher in the hierarchy.

ATTRIBUTES are not shown in the diagram for brevity. Any MDR, INSTRUMENT, COMMON, TELEMETRY, TELEMETRY_ITEM, COMPONENT, AGGREGATE, REF_COMPONENT, REF_VARIANT, DEPENDENCY, or CONVERSION element may contain one or more ATTRIBUTE elements. The ATTRIBUTE element is used to provide further information where the MDR specification does not have an analogous XML element within its specification

Table 1.5.3-1, MDR Format

Field Name	Length (Bytes)	Data Type	Range of Values	Units	Comments
MDR	N/A	Complex Type	Subfields: TITLE PAGE RCR PAGE INSTRUMENT COMMON ATTRIBUTE	N/A	Required This is the root element for the Application Packet Format Database.
COMMON	N/A	Complex Type	Subfields ATTRIBUTE AGGREGATE COMPONENT VARIANT CONVERSION CONSTANT	N/A	This element specifies common elements that are reusable across the entire MDR, and so can be used by any instrument. Common components can be multiply-referenced for repeated use in multiple packet types.
TITLE PAGE	N/A	Complex Type	Subfields doc_title doc_num cage number cdrl number revision	N/A	Required Constrained to one instance. The subfields of this element provide the same information that would be shown on the title page of a conventional engineering released document.

Field Name	Length (Bytes)	Data Type	Range of Values	Units	Comments
RCR PAGE	N/A	Complex Type	Subfields revision document_date Revision_description Release_type Part_1_release_version	N/A	Required Constrained to from one to many instances. The subfields of this element provide the same information that would be shown on the RCR page of a conventional engineering released document.
INSTRUMENT	N/A	Complex Type	Subfields ATTRIBUTE TELEMETRY DESCRIPTION COMMON	N/A	This element contains the AP formats for a specific instrument, such as CrIS, VIIRS etc. Each instrument has its own INSTRUMENT element. The COMMON element within the INSTRUMENT element contains common elements used for the specific instrument.
ATTRIBUTE	N/A	Complex Type	Subfields name value	N/A	Information that is not contained in MDR specifications are handled in this optional element. Examples of ATTRIBUTES include apid, detector, start_bit, units, nbits, telemetry_point_id, and display_name.
AGGREGATE	N/A	Complex Type	N/A	N/A	The AGGREGATE construct is used to create structures by combining other elements into a group. An AGGREGATE contains one or more child elements of type COMPONENT, AGGREGATE, or VARIANT. Examples are primary and secondary headers, and packet data.
COMPONENT	N/A	Complex Type	Subfields CONVERSION REF_CONVERSION ENUMERATIONS ATTRIBUTE	N/A	A COMPONENT element is the lowest level type in the MDR. The COMPONENT describes a primitive data type such as a character string, floating point, fixed point, unsigned integer, signed integer, or undef. A COMPONENT may contain a specification for a CONVERSION.

Field Name	Length (Bytes)	Data Type	Range of Values	Units	Comments
VARIANT	N/A	Complex Type	Attributes ATTRIBUTE DEPENDENCY AGGREGATE COMPONENT REF_COMPONENT REF_VARIANT VARIANT	N/A	<p>Within a VARIANT one or more COMPONENT, DEPENDENCY and/or AGGREGATE elements can be present.</p> <p>Defines a variant element that can be employed within a parent element. The variant is dependent on a component used within the same contextual level as the variant being defined.</p> <p>VARIANTS are used for elements such as EU CONVERSIONS.</p> <p>Any place that a VARIANT appears in the specification (except under COMMON) may use the REF_VARIANT element to reference a VARIANT defined in a COMMON element that is higher in the hierarchy.</p>
CONVERSION	N/A	Complex Type	Subfields DEPENDENCY math Attributes coefficients eu_type	N/A	<p>The CONVERSION may contain one or more VARIANT elements, with contained DEPENDENCY elements.</p> <p>The math (lower case) element contains a W3C content MathML expression that specifies a calcurve or raw-to-engineering unit (EU) conversion equation to be used with the parent component.</p> <p>Attributes are used to give the coefficients and type of eu conversion, such as polynomial.</p> <p>May include VARIANTS that define mathematical formulas, and DEPENDENCY elements, such as name, value, and operation (e.g. equality, greater than, etc.)</p>

Field Name	Length (Bytes)	Data Type	Range of Values	Units	Comments
CONSTANT	N/A	Complex Type	Attributes name value type	N/A	A CONSTANT can be any valid JavaScript expression.
doc_title	N/A	String	NPOESS Common Data Format Control Book - External Volume VII - NPOESS Downlink Data Formats - ABCD Telemetry - Part nn, where 'ABCD' and 'nn' will change for each instrument.	N/A	Required Constrained to one instance. The title of the document as it would appear on a title page of a conventional engineering released document. It reflects the instrument and part (2-5) of Vol. VII contained in this XML document.
doc_num	N/A	String	D34862-07-nn, where 'nn' will indicate Part 2, 3, etc of the document, and so will change depending on the instrument (CrIS, VIIRS etc.) packets contained.	N/A	Required Constrained to one instance. The document number of the document as it would appear on a title page of a conventional engineering released document. It reflects the instrument and part (2-5) of Vol. VII contained in this XML document.
cage number	N/A	String	11982	N/A	Required Constrained to one instance, and contains a fixed value. The cage number of the document as it would appear on a title page of a conventional engineering released document.

Field Name	Length (Bytes)	Data Type	Range of Values	Units	Comments
cdrl number	N/A	String	A014	N/A	Required Constrained to one instance, and contains a fixed value. The CDRL number of the document as it would appear on a title page of a conventional engineering released document.
Revision	N/A	String		N/A	Required Constrained to one instance. The revision of the document as it would appear on a title or RCR page of a conventional engineering released document. Revision indicates the release version for this part of Vol VII. This will normally be synchronized with the corresponding release of the NPOESS Command & Telemetry Database (NCTDB).
document_date	N/A	String		N/A	Required Constrained to one instance. The release date of the document as it would appear on an RCR page of a conventional engineering released document.
Revision_description	N/A	String		N/A	Required Constrained to one instance. The release description of the document as it would appear on an RCR page of a conventional engineering released document. This text describes the release including the change ECR number and a brief description of the change.

Field Name	Length (Bytes)	Data Type	Range of Values	Units	Comments
Release_type	N/A	String	Full or Patch	N/A	Required Constrained to one instance. The release type of the document as it would appear on an RCR page of a conventional engineering released document. Release type indicates whether the release is a "Full" or "Patch".
Part_1_release_version	N/A	String		N/A	Required Constrained to one instance. The revision number of the associated Part 1 of this document, i.e. if Part 1 was D34862-07-01---, then Part_1_release_version would be '---.' This field allows for version correlation of the two document parts that may, or may not, be released simultaneously.
DESCRIPTION	N/A	String		N/A	Optional element to add large blocks of descriptive text.
TELEMETRY	N/A	Complex Type	Subfield TELEMETRY_ITEM ATTRIBUTE COMMON	N/A	Defines the telemetry points within the instrument. The TELEMETRY element contains a COMMON element and a list of TELEMETRY_ITEMS, each of which describes a telemetry mnemonic for this instrument.

Field Name	Length (Bytes)	Data Type	Range of Values	Units	Comments
TELEMETRY_ITEM	N/A	Complex Type	Attributes name mnemonic description apid telemetry_point_id start_bit nbits units	N/A	A TELEMETRY_ITEM contains one or more VARIANT elements, such as a DEPENDENCY element.
DEPENDENCY	N/A	Complex Type	Attributes name op (operation) value (result of operation)	N/A	A DEPENDENCY describes a COMPONENT in the same level of the hierarchy that this VARIANT depends on. Thus, a VARIANT with a DEPENDENCY is not considered unless the dependent COMPONENT matches the dependency.
CONVERSION	N/A	Complex Type	Variants DEPENDENCY math	N/A	A DEPENDENCY, if present, specifies that this conversion will be applied only if the component evaluates to true as specified in the dependency. The math is the MATHML specification for this EU conversion.

2.0 NPOESS Downlink Data Structures

The layered LRD/HRD/SMD downlink protocol formatting described in the following subparagraphs specifies the NPOESS implementation of the following CCSDS downlink protocol formats:

- Application Packet (AP)
- Multiplex Protocol Data Unit (MPDU)
- Coded Virtual Channel Data Unit (CVCDU)
- Channel Access Data Unit (CADU)

The NPOESS external downlink structures are shown below in Figure 2.0-1, NPOESS External Downlink Data Structures. Internal downlink structures are specified in the Internal Data Format Control Book, Volume II – Uplink and Downlink Data Transport Formats, D36953-02.

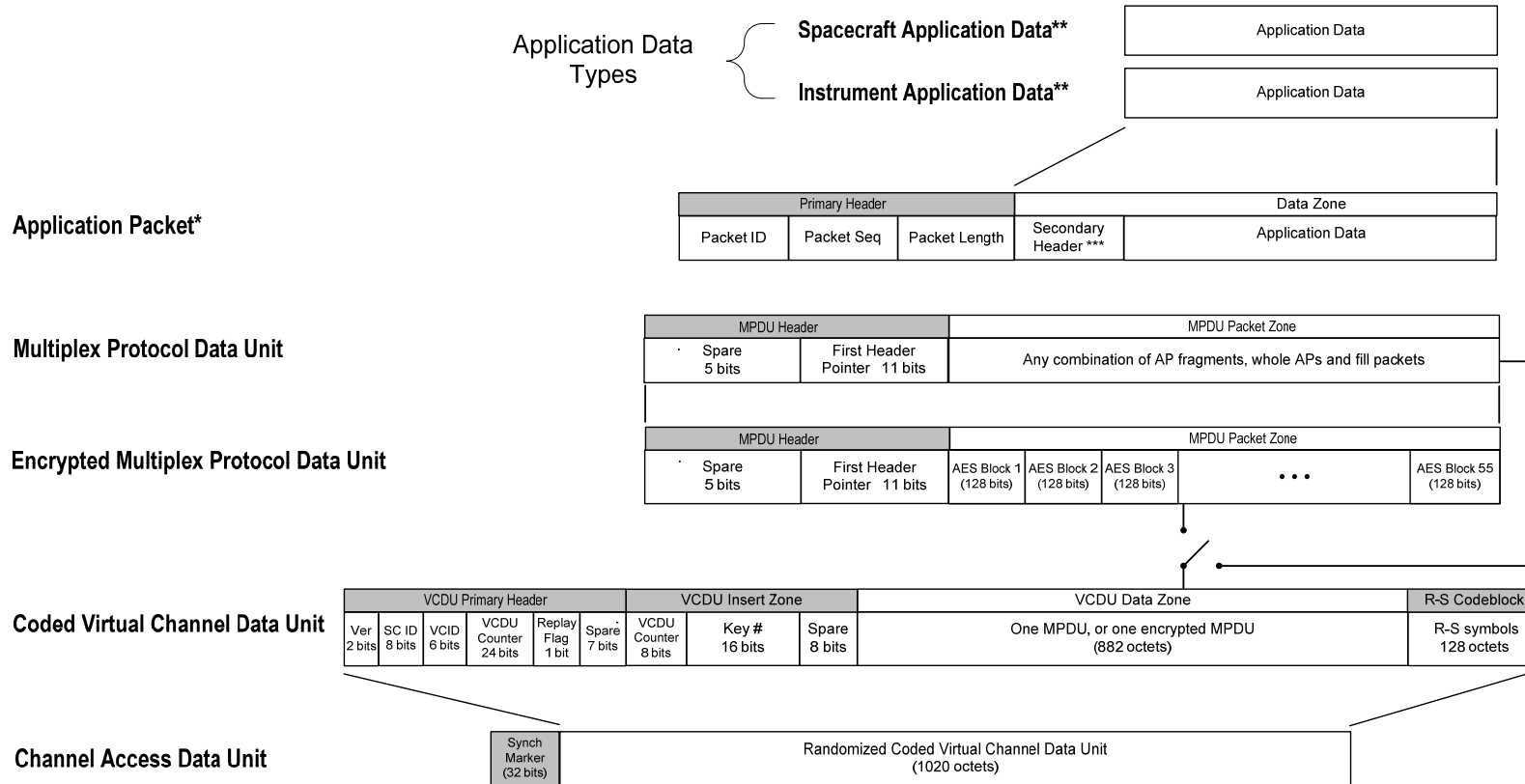

* The structure shown is for a standalone packet – see section 2.1.1.3 for packet sequence structures (not shown here)

** These data types can exceed the max length for a standalone packet resulting in a packet sequence

*** Secondary packet header is not present on all NPOESS application packet types

Note 1: Shadowed structures indicate protocol unit encapsulation layers

Note 2: Multiplex protocol insertion not shown

Figure 2.0-1 NPOESS External Downlink Data Structures

2.1 Application Packet

Data Mnemonic	SS_C3-L22000-000
Description	NPOESS application packets are data structures generated onboard the satellite by the various spacecraft and payload applications. The format of the application packets is unique for each application packet type. The application packet types are identified by their application process identifier (APID). Packet types are included in the LRD/HRD/SMD downlink channels by their assigned virtual channel identifier (VCID) in accordance with the NPOESS Data Mapping Document, D35853.
File-Naming Construct	N/A
Data Size	See section 2.1.1.1 below
File Format Type	Not Applicable
Production Frequency	Variable
Data Content and Data Format	<p>The NPOESS APs contain telemetry, mission data, or mission support data depending on the AP type. The data content for externally-delivered application packets is specified in Parts 2-5 of this document.</p> <p>The structure of NPOESS APs is shown below in Table 2.1.1-1, NPOESS Application Packet Structure and in the following subparagraphs.</p>

2.1.1 Application Packet Structure

When the application data length is less than or equal to the maximum AP length, generally that data will be encapsulated with the header fields defined herein as a single standalone packet. However, when the application data exceeds the maximum AP length, it will be segmented and encapsulated into a packet sequence. Spacecraft and instrument APs may be standalone or segmented into a packet sequence according to their length. (Note: some application packets may be segmented on boundaries less than the maximum AP length to provide more logical grouping of the data within the packet sequence.) Maximum application data length is discussed below in section 2.1.1.1. The general structure of all NPOESS application packets is shown in Table

2.1.1-1, NPOESS Application Packet Structure. Exceptions for fill packets are noted where applicable. Application packet structures specific to packet segmentation are discussed below.

Table 2.1.1-1, NPOESS Application Packet Structure

Segment	Quantity	Description
Primary Header	1	Contains parameters indicating packet attributes and destination
Secondary Header	0 or 1	May be present in standalone packets Always present in the first packet of a sequence Not present in continuation packets or last packet structures in a sequence
Application Data	1	Contains spacecraft or payload application data

2.1.1.1 Application Packet Length

Application packet maximum lengths are specified in Table 2.1.1.1-1, Application Packet Lengths, according to their type, or onboard routing. See Parts 2 - 5 of this volume for the actual lengths of each specific AP type. When application data exceeds the lengths shown, that application data will be encapsulated in a packet sequence.

Table 2.1.1.1-1, Application Packet Lengths

Packet Description	Maximum Packet Length	Maximum Application Data Length
Application packets routed from spacecraft onboard destinations via MIL-STD-1553 data bus	1024 octets	1018 octets minus the secondary header length, when present
Application packets routed from instruments via spacecraft MIL-STD-1553 data bus	1024 octets Even number of octets only	1018 octets minus the secondary header length, when present
Application packets routed from instruments via IEEE-1394 data bus	65507 octets	65501 octets minus the secondary header length when present
Spacecraft controller telemetry including memory dump	256 octets	250 octets minus the secondary header length when present
Fill packet	880 octets	874 octets maximum 1 octet minimum

2.1.1.2 Standalone Application Packet Structure

Standalone packets are structured as shown below in Table 2.1.1.2-1, Standalone Application Packet Structure. The absence or presence of a secondary header is as indicated for each AP type in Parts 2-5 of this volume.

Table 2.1.1.2-1, Standalone Application Packet Structure

Segment	Quantity	Description
Primary Header	1	Contains parameters indicating packet attributes and source
Secondary Header	0 or 1	Contains an AP generation time stamp
Application Data	1	Contains spacecraft or payload application data

2.1.1.3 Segmented Application Packet Structure

When segmented, the first packet in the packet sequence is structured differently from the continuation and last packets. These structures shown below in Figure 2.1.1.3-1, Packet Sequence Structure.

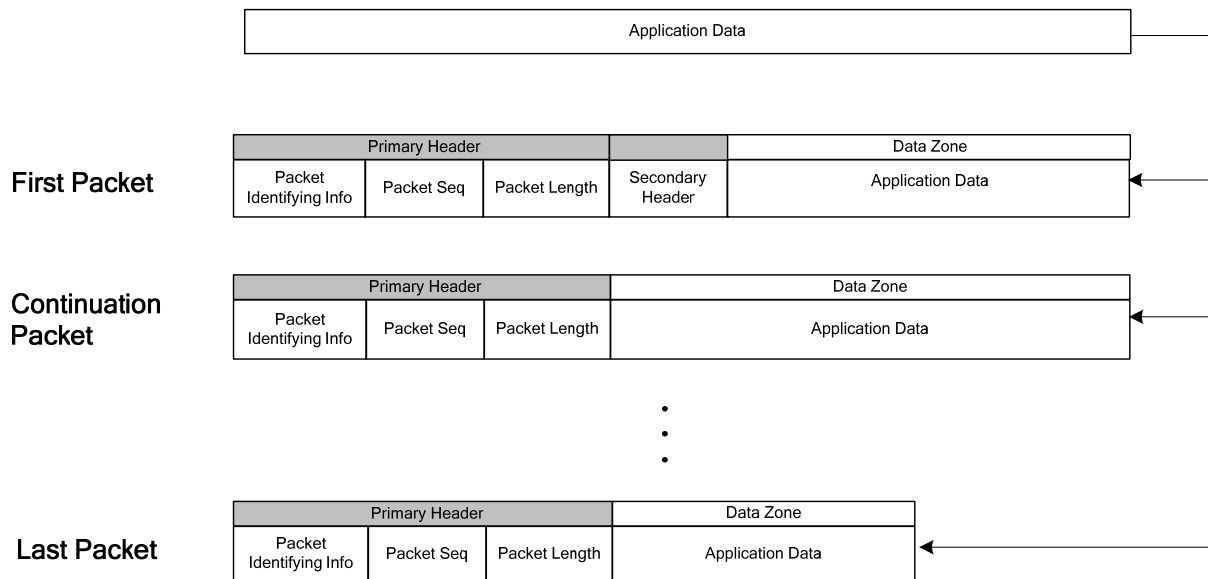

When spacecraft application data exceeds the the maximum source data length, it is segmented and packed into the data zones of a packet sequence according to the application data length

Figure 2.1.1.3-1, Packet Sequence Structure

2.1.1.3.1 Packet Sequence First Packet Structure

The first packet in a packet sequence is structured with a secondary header as shown below in Table 2.1.1.3.1-1, Packet Sequence - First Packet Structure.

Table 2.1.1.3.1-1, Packet Sequence - First Packet Structure

Segment	Quantity	Description
Primary Header	1	Contains parameters indicating packet attributes and destination
Secondary Header	1	Contains an AP generation time stamp and the number of packets in this sequence minus 1
Application Data	1	Contains spacecraft or payload application data

2.1.1.3.2 Packet Sequence - Continuation and Last Packet Structure

The structures of the continuation and last packets in a packet sequence are structured without a secondary header as shown below in Table 2.1.1.3.2-1, Packet Sequence - Continuation and Last Packet Structure.

Table 2.1.1.3.2-1, Packet Sequence - Continuation and Last Packet Structure

Segment	Quantity	Description
Primary Header	1	Contains parameters indicating packet attributes and destination
Application Data	1	Contains spacecraft or payload application data

2.1.2 Application Packet Field Contents

The NPOESS application packet field contents are described in the following paragraphs.

2.1.2.1 Application Packet Primary Header Field Contents

The NPOESS application packet primary header field contents are described in Table 2.1.2.1-1, Application Packet Primary Packet Header - Field Contents.

Table 2.1.2.1-1, Application Packet Primary Header - Field Contents

	Field Name	Length	Description
Packet Identifying Information 2 octets	Version Number	3 bits	0b 000 indicates CCSDS version-1 packet
	Type	1 bits	0b 0 – Indicates telemetry
	Secondary Header flag	1 bit	0b 0 = absent, '1' = present 0b 0 for fill packets
	APID	11 bits	NPOESS receiving APID - specified in the NPOESS Data Mapping Document, D35853 2047 ₁₀ indicates a fill packet
Packet Sequence 2 octets	Sequence Flag	2 bits	0b 00 indicates a continuation packet 0b 01 indicates a first segment packet 0b 10 indicates a last segment packet 0b 11 indicates a standalone packet 0b 11 for fill packets
	Packet Sequence Counter	14 bits	Monotonically increasing packet sequence counter per APID - rolls over to zero after reaching 16,383 0x 0000 for fill packets
Packet Length 2 octets	Packet Data Length	16 bits	Packet length as # of octets minus 1 for the combined secondary header length and application data segment length – see Table 2.1.1.1-1 for max AP data lengths

2.1.2.2 Application Packet Secondary Header Field Contents

The NPOESS AP secondary header field contents are dependent on whether the AP is a standalone packet or the first packet in a packet sequence.

2.1.2.2.1 Standalone AP Secondary Header Field Contents

Standalone AP secondary header field contents are described in Table 2.1.2.2.1-1, AP Secondary Header - Field Contents.

Table 2.1.2.2.1-1, Standalone AP Secondary Header - Field Contents

Field Name	Length	Description
Day	16 bits	Number of days since 1 January 1958
millisecond of day	32 bits	Number of milliseconds since start of day
microseconds	16 bits	Number of microseconds of each millisecond (0 – 999)

2.1.2.2.2 Packet Sequence – First Packet Secondary Header Field Contents

Packet Sequence AP secondary header field contents are described in Table 2.1.2.2.2-1, AP Secondary Header - Field Contents.

Table 2.1.2.2.2-1, Packet Sequence AP Secondary Header - Field Contents

Field Name	Length	Description
Day	16 bits	Number of days since 1 January 1958
millisecond of day	32 bits	Number of milliseconds since start of day
microseconds	16 bits	Number of microseconds of each millisecond (0 – 999)
Total Packet Sequence Count	8 bits	Number of packets in this packet sequence minus 1
Spare	8 bits	0x 00 - unused

2.1.2.3 Application Packet Source Data Field Contents

The NPOESS AP application data field contents are described in Table 2.1.2.3-1, AP Application Data - Field Contents.

Table 2.1.2.3-1, AP Application Data- Field Contents

Field Name	Length	Description
Application Data	See Table 2.1.1.1-1, Application Packet Lengths	The application data format for externally-delivered APs is the subject of Parts 2-5 of this volume Repeating 0x 00 octets for fill packets

2.2 Multiplexing Protocol Data Unit

Data Mnemonic	SS_C3-L22000-010
Description/ Purpose	The Multiplexing Protocol Data Unit (MPDU) is the CCSDS data structure used to multiplex APs into a fixed-length structure for transport through a specified virtual channel.
File-Naming Construct	Not Applicable
Data Size	882 Octets
File Format Type	Not Applicable
Production Frequency	Varies with packet type and the operational mode of the AP source
Data Content and Data Format	The structure and content of MPDUs is shown below in Table 2.2-1, MPDU Structure.

Table 2.2-1, MPDU Structure

Segment	Quantity	Description
MPDU Header	1	Contains an offset value to indicate the location of the first packet's start octet
MPDU Packet Zone	1	Contains any combination of AP fragments, whole APs and fill packets according to what will fit into this fixed-length segment

2.2.1 MPDU Header Field Contents

The MPDU header field contents are specified in Table 2.2.1-1, MPDU Header – Field Contents.

Table 2.2.1-1, MPDU Header - Field Contents

Field Name	Length	Description
Spare	5 bits	0b 00000 - Unused
First Header Pointer	11 bits	Number of octets into the MPDU packet zone minus 1, (offset - 1) to the start octet of the first packet header, or 0x 7FF indicates that no packet header start octet is present in the MPDU packet zone 0x 7FE indicates fill data

2.2.2 MPDU Packet Zone Field Contents

The MPDU packet zone contains the contents described below in section 2.2.2.1. As determined by VCID and the application, or not, of Selective Data Encryption Mode, the MPDU packet zone described in section 2.2.2.1 may be additionally formatted as described in section 2.2.2.2.

2.2.2.1 Unencrypted MPDU Packet Zone Field Contents

For unencrypted virtual channels, the MPDU packet zone field contents are specified in Table 2.2.2-1, MPDU Packet Zone – Field Contents.

Table 2.2.2-1, MPDU Packet Zone - Field Contents

Field Name	Length	Description
Application Packets	880 octets	Any combination of AP segments and/or whole APs and/or fill packets parsed into 880 octet segments from the AP generation output stream of a specific virtual channel

2.2.2.2 Encrypted MPDU Packet Zone Field Contents

For encrypted virtual channels, the MPDU Packet Zone described in section 2.2.2.1 will be parsed into a sequence of 55, 128-bit data blocks, encrypted, and then formatted into a contiguous sequence of 55, 128-bit AES data blocks. The 16-bit encryption key used to encrypt the data blocks is specified by serial number in the VCDU “key #” field.

2.3 Coded Virtual Channel Data Unit

Data Mnemonic	SS_C3-L22000-020
Description/ Purpose	The coded virtual channel data unit (CVCDU) is an MPDU encapsulated with channel information and is also coded for and appended with Reed-Solomon error correction symbols. This data structure facilitates coded multiplexing of the physical downlink channel.
File-Naming Construct	N/A
Data Size	1020 Octets
File Format Type	Not applicable
Production Frequency	Variable
Data Content and Data Format	The CVCDU structure is shown below in Table 2.3-1, CVCDU Structure. The segment field contents are shown in the following subparagraphs.

Note that the CVCDU structure, shown in Table 2.3-1 applies to LRD/HRD/SMD, which is different than the CVCDU structure used to downlink S-band telemetry. The S-band CVCDU is specified in the Internal Data Format Control Book Volume II – Uplink and Downlink Data Transport Formats, D36953-02.

Table 2.3-1, CVCDU Structure

Segment	Quantity	Description
VCDU Primary Header	1	Contains spacecraft and channel identification
VCDU Insert Zone	1	Contains VCDU counter extension and encryption key #
VCDU Data Zone	1	Contains 1 MPDU
Reed-Solomon Codeblock	1	Contains error detection and correction symbols

2.3.1 CVCDU Primary Header – Field Contents

The CVCDU primary header field contents are specified in Table 2.3.1-1, CVCDU Primary Header Field Contents.

Table 2.3.1-1, CVCDU Primary Header - Field Contents

Field Name	Length	Description
Version Number	2 bits	0b 01 – fixed value - indicates that this is a VCDU structure
Spacecraft Identifier	8 bits	0x 7B indicates the C1 spacecraft 0x 7C indicates the C2 spacecraft
Virtual Channel Identifier	6 bits	NPOESS VCIDs are identified in the NPOESS Data Mapping Document, D35853 0x3F – Indicates a fill VCDU
VCDU Counter	24 bits	24 LSBs of a 32-bit monotonically increasing VCDU sequence counter per VCID Rolls over to 0x 000000 after reaching 0x FFFFFFFF Contains 0x 000000 for fill VCDUs
Replay Flag	1 bit	0b 0 – Unused
Spare	7 bits	0x 00 – Unused

2.3.2 CVCDU Insert Zone – Field Contents

The CVCDU insert zone field contents are specified in Table 2.3.2-1, CVCDU Insert Zone - Field Contents.

Table 2.3.2-1, CVCDU Insert Zone - Field Contents

Field Name	Length	Description
VCDU Counter (extension)	8 bits	8 MSBs of a 32-bit monotonically increasing VCDU sequence counter per VCID Rolls over to 0x 00 after reaching 0x FF. Contains 0x 00 for fill VCDUs
Key #	16 bits	0x 0000 – indicates an unencrypted MPDU packet zone 0x XXXX – 16-bit serial number of the AES key used to encrypt the MPDU packet zone
Spare	8 bits	0x 00 - Unused

2.3.3 CVCDU Data Zone Contents

The VCDU data unit zone contains either one unencrypted MPDU, or one encrypted MPDU. A fill VDCU contains a MPDU that has its packet zone filled with a MPDU header and 880 - 0x 55 octets.

2.3.4 Reed Solomon Codeblock Segment Contents

The Reed-Solomon check symbol segment is a 128-octet block of error-detecting and error-correcting check symbols generated with the following Reed-Solomon parameters:

Bits per R-S symbol (J): 8

R-S error correction capability (E): 16

Interleaving depth (I): 4

This configuration provides coding for the 892 octet codeword input including the VCDU Primary Header, the VCDU Insert Zone, and the VCDU Data Zone, resulting in a 128 octet R-S codeblock. This encoding methodology is described in the Telemetry Channel Encoding Blue Book, CCSDS 101.0-B-6. This same NPOESS R-S encoding configuration is discussed in other program documentation designated as (255; 223) where 255 is the number of R-S symbols per codeword. Of the 255 R-S symbols, 32 represent parity checks and 223 represent information.

2.4 Channel Access Data Unit

Data Mnemonic	SS_C3-L22000-030
Description/ Purpose	The channel access data unit (CADU) structure encapsulates the CVCDU structure with a pre-pended synchronization marker to provide a means for determining the CVCDU structure starting point.
File-Naming Construct	N/A
Data Size	1024 Octets
File Format Type	Not Applicable
Production Frequency	Variable
Data Content and Data Format	The segment field contents are shown in the following subparagraphs.

2.4.1 CADU Structural Elements

The CADU structure is shown below in Table 2.4.1-1, CADU Structure.

Table 2.4.1-1, CADU Structure

Segment	Quantity	Description
Synchronization Marker	1	Contains a fixed value
Randomized CVCDU	1	Contains one randomized CVCDU

2.4.1.1 Synchronization Marker – Field Contents

The synchronization marker is a 32 bit field containing the value:

0x 1ACF FC1D

2.4.1.2 Randomized CVCDU – Field Contents

This field contains a CVCDU that has been randomized by exclusively OR-ing each bit

with a pseudo-random sequence. The polynomial used to generate the pseudo-random sequence is as follows: $h(x) = x^8 + x^7 + x^5 + x^3 + 1$.

2.4.2 CADU Encoding

CADUs are additionally encoded with non-return to zero – mark (NRZ-M) encoding, and convolutional encoding.

2.4.2.1 NRZ-M Encoding

NRZ-M encoding changes each bit state every time that a "one" occurs, but when a "zero" occurs, it remains the same, i.e., no transition occurs.

2.4.2.2 Convolutional Encoding

The CADU is convolutionally encoded as described in the CCSDS Telemetry Channel Encoding Blue Book, CCSDS 101.0-B-6 as “basic convolutional coding”. The code rate is $\frac{1}{2}$, which is a rate of one data bit to two channel symbols. The convolutional encoder constraint length is 7, and convolutional encoder's connection vectors are 1111001 for G1 and 1011011 for G2.

2.5 Fill CADU

Data Mnemonic	SS_C3-L22000-031
Description/ Purpose	<p>The Fill CADU is inserted into the data stream to fill the channel bandwidth in the case when there is insufficient Telemetry or Mission Data, ensuring a constant transmission bit-rate.</p> <p>The APID of the fill packet within the Fill CADU is 2047</p>
File-Naming Construct	N/A
Data Size	882 Octets in the data zone
File Format Type	Not Applicable
Production Frequency	Dynamic
Data Content and Data Format	<p>The VCID field of a fill CADU is set to all ones (binary 111111 = decimal 63) to identify fill CADU packets.</p> <p>The VCDU counter field of a fill CADU is set to all zeros.</p> <p>The MPDU Packet zone field of a fill CADU packet consists of 882 octets set to 0x55. There is no secondary header for a fill packet.</p>

2.6 Marker Block CADU

Data Mnemonic	SS_C3-L22000-032
Description/ Purpose	<p>Marker CADUs are used to index the contents of data on the SMD partition of the SSR. The SMD Partition is logically divided into an integer number of blocks as illustrated in Figure 2.6-1, Block Structure of SMD Partition on SSR. A nominal block consists of a Marker CADU and 1023 SMD/S-TLM CADUs. (The DSU is configurable for 2048, 4096, or 8192 CADU block sizes, each ending with a Marker CADU. However, a 1024 CADU block size is the value being used for NPOESS. The Marker CADU contains information about the data content between Marker CADUs, and is used by the MMC to manage requests for retransmissions of SMD.</p> <p>The APID of the marker packet within the Marker Block CADU is 32.</p>
File-Naming Construct	N/A
Data Size	1024 Octets
File Format Type	Not Applicable
Production Frequency	Every 1024 CADUs
Data Content and Data Format	<p>Each Marker CADU contains a Marker Packet as shown in Figure 2.6-2, Marker CADU Structure. A fill CCSDS packet is appended to the Data Zone of the Marker CADU to complete the 880 octets. The Marker Packet contains a unique Marker ID corresponding to the storage location in the SSR SMD Partition; this is incremented each time a Marker Block is written to the SMD. The packet also contains a snapshot of the current VCDU sequence counter for each VCID, which gives the Sequence Count for the first occurrence of each of the SMD/STLM VCIDs contained in the Marker Block.. The field contents are shown in Figure 2.6-3, Marker Packet Field Contents; note that there is no secondary header for this packet.</p>

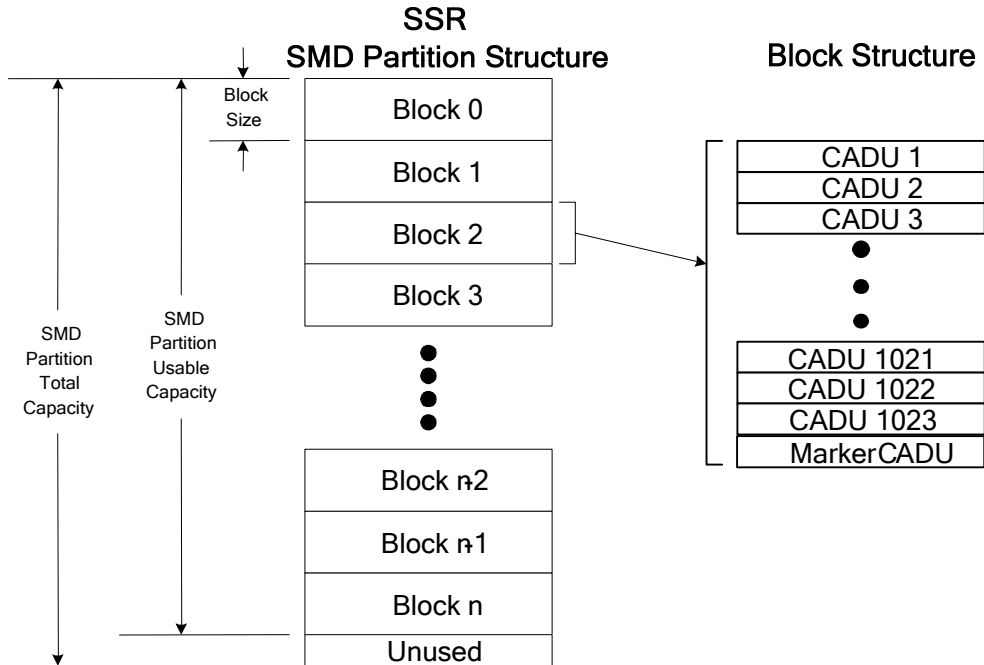

Figure 2.6-1, Block Structure of SMD Partition on SSR

The Marker Packet CADU format is shown below in Figure 2.6.-2, Marker CADU structure.

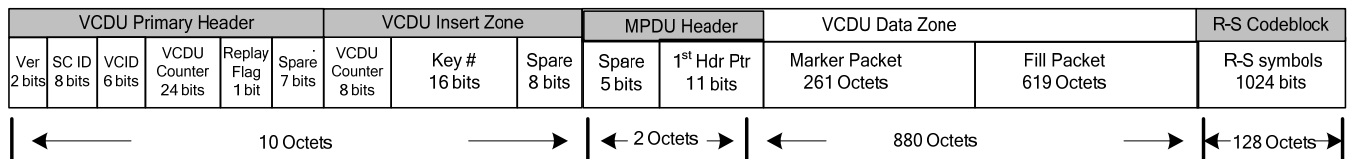

Figure 2.6-2, Marker CADU Structure

The field contents described in Section 2.6 are shown below in Figure 2.6-3, Marker Packet Field Contents.

Marker Packet								
Primary Header			Packet Data					
Packet ID	Packet Seq	Packet Length	2040 bits = 255 Bytes					
16 bits	16 bits	16 bits	7 bits	17 bits	32 bits	32 bits		32 bits
00000 Bits 0-4 Marker APID Bits 5-15	Pkt Sq 2 bits Sq Ct 14 bits	Data Length-1 (octets)	Spare	Marker ID	Seq Cnt VCID 0	Seq Cnt VCID 1	Seq Cnt VCID 62

Figure 2.6-3, Marker Packet Field Contents

3.0 NPOESS Spacecraft Bus

The Spacecraft bus provides the instrument payload with a stable platform, supplies space to ground communication links, manages power and thermal functions to maintain a sound Satellite condition, and provides failsafe protection in the event of anomalous conditions

3.1 Spacecraft SCP Auxiliary Data

Data Mnemonic	SS_NU-L00000-001
APID	8 SCP Auxiliary Data
Description	<p>The Auxiliary Spacecraft SCP Data contains the specific SC orbital and position data that has been filtered by the onboard GPS receiver, and attitude data generated on-board the satellite. SC ephemeris and attitude auxiliary data is used within IDPS and FTS for the processing and geolocation of NPOESS data products.</p> <p>The packet contains data primarily from the attitude control subsystem. SC ephemeris is gathered from the GPSR. Attitude is determined onboard, referenced using an Inertial Reference Unit updated with Star Tracker measurements. This data is time tagged for each item as they are not produced at the same time and are not synchronous with each other.</p>
Packet Size	The packet may be 880 octets or it may consist of a set of smaller packets. This is EDFCB7-TBR-10510
Availability	This application packet is generated when the spacecraft is in Operational State.
Frequency	The SC ephemeris and attitude auxiliary data sent in this packet is processed in the SCP every 2 seconds. The packet is downlinked when ready (i.e. every 2 seconds). The sampling frequency of the attitude data is 2.0 Hz so only four attitude samples are contained in each packet. The sampling frequency of the ephemeris (GPS) data is 0.1 Hz causing the same value to be repeated 5 times.
Data Content and Data Format	<p>The contents of the Spacecraft Auxiliary SCP application packet are expected to include the following. This is EDFCB7-TBR-10514:</p> <p>SC ID</p> <p>Ephemeris Time of Day (As provided by the GPSR)</p> <p>GPSR Raw SC Position X, Y, Z</p> <p>GPSR Raw SC Velocity X, Y, Z</p> <p>4 of 20 Attitude Time of Day and Attitude Quaternions</p> <p>Indicator of ACS fine point state (e.g., EPM, FPM etc) (1 of 8 possible states for this indicator)</p>

Current Geographically Constrained ODAD table indicator

(Null indicates none active)

Current VCID-to-Link map indicator for SCP

Current APID-to-VCID map indicator for SCP

Current APID-to- Compression Ratio indicator

The format is: **EDFCB7-TBD-10408**

3.2 Spacecraft DSU Auxiliary Data

Data Mnemonic	SS_NU-L00000-002
APID	11 DSU Auxiliary Data
Description	Spacecraft DSU auxiliary data is collected in this application packet to support processing of RDRs to Sensor Data Records (SDRs). This packet is produced by the DSU and contains current table indicators for APID-to-VCID, VCID-to-Link & Compression Ratio maps.
Packet Size	The packet size is expected to be determined in tandem with the SCP Auxiliary Data packet. This is EDFCB7-TBR-10510.
Availability	The Spacecraft Auxiliary Spacecraft DSU Data application packet is generated when the spacecraft is in Operational State.
Frequency	This data from the DSU is processed every 2 seconds but contains data that changes infrequently. Because it shares a VCID and so is transmitted with APID 8 (above), transmission may be delayed by up to 2 seconds when this packet is produced slightly later than APID 8.
Data Content and Data Format	<p>The contents of the application packet are expected to include the following. This is EDFCB7-TBR-10515:</p> <ul style="list-style-type: none"> SCID Current VCID-to-Link map indicator for DSU Current APID-to-VCID map indicator for DSU Current APID-to- Compression Ratio indicator <p>The format is: EDFCB7-TBD-10507</p>

4.0 Sensor Data

4.1 Visible/Infrared Imager Radiometer Suite

4.1.1 VIIRS Instrument Overview

The VIIRS Sensor is a nadir viewing, cross-track observing, continuously operating electro-optical imaging sensor. It is designed to collect Earth and atmospheric scene spectral radiance in 22 channels spanning the visible through infrared spectrum, and send this data as CCSDS application packets to the NPOESS spacecraft for transmission to the ground. The 22 channels include 16 moderate resolution bands, 5 imaging resolution bands (which have twice the resolution of the moderate resolution bands), and a Day Night Band (DNB). The latter obtains imagery throughout both the day and night portions of the orbit. The VIIRS flies in a sun synchronous orbit that provides the along track component of the image. The cross track scan is implemented using optics and a rotating telescope as indicated in Figure 4.1.1-1, VIIRS Simplified Design Concept.

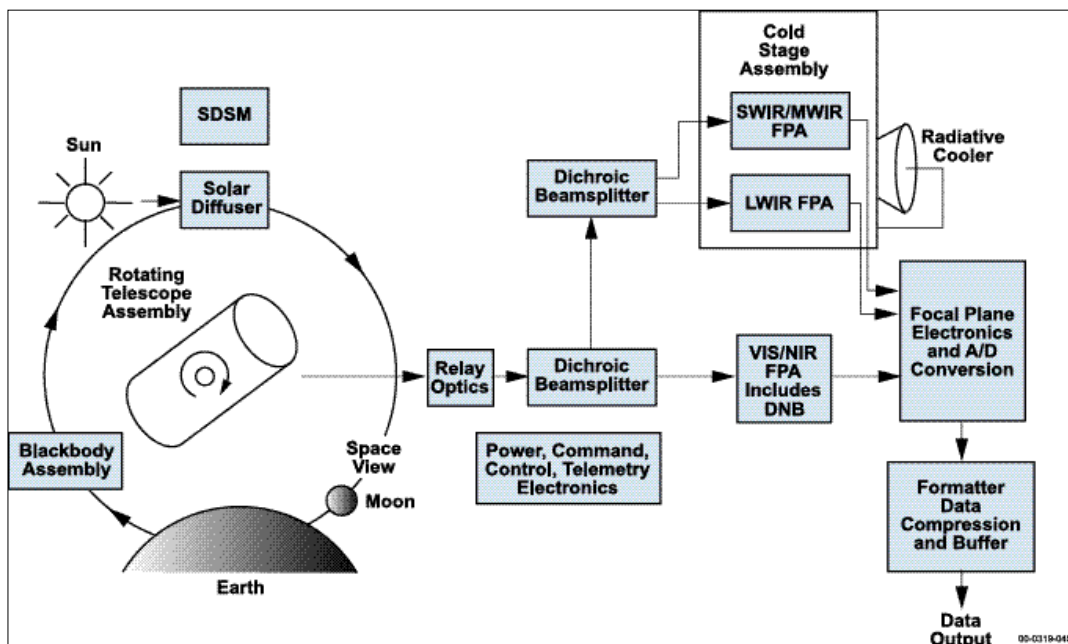

Figure 4.1.1-1, VIIRS Simplified Design Concept

Figure 4.1.1-2, VIIRS ANTI-Solar/Travel-Direction Sides & OMM Interface Mounts, illustrates the VIIRS Sensor from a downward-viewing perspective showing the mounting surfaces. As shown, the Sensor consists of two modules separately mounted to the spacecraft. The Opto-Mechanical Module contains all of the optical and mechanical assemblies required to collect Earth and calibration data including scanning optics, focal planes, and calibration sources. The Electronics Module provides all of the electrical interfaces to the NPOESS spacecraft. In response to spacecraft commands, it controls the VIIRS configuration, operates the mechanisms in the Opto-Mechanical Module and collects and formats the data from the focal planes and transmits it to the spacecraft. The Electronics module bolts to a nadir-facing Spacecraft cold plate (not shown).

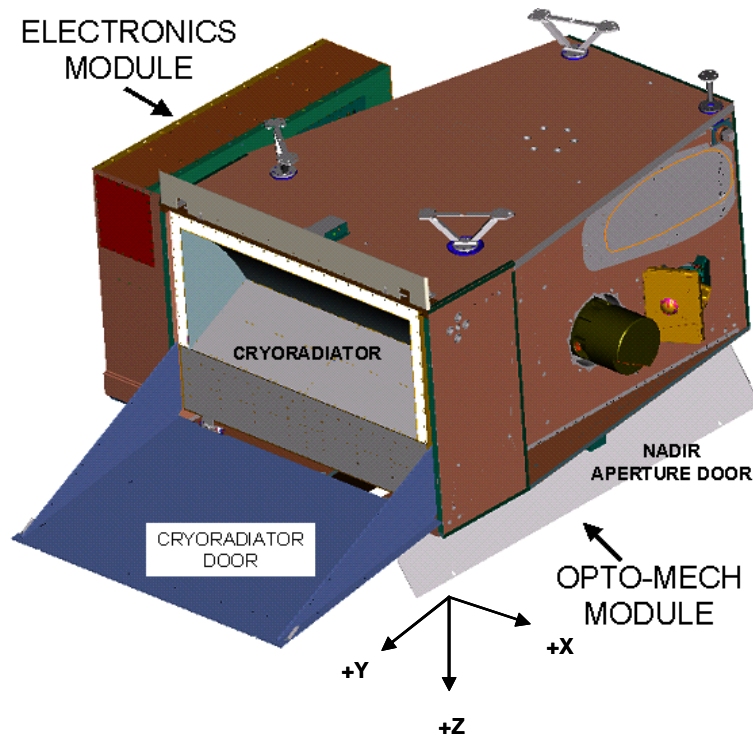

Figure 4.1.1-2, VIIRS ANTI-Solar/Travel-Direction Sides & OMM Interface Mounts

The scanning optics sweep the linear detector over the earth collecting of 22 coincident

swaths of data (one per band), 16 or 32 samples wide. The moderate resolution and Day Night bands have 16 detectors and the imaging bands have 32 detectors arranged in an along-track linear configuration. The scan width on earth is just over 3,000km, although other widths can be programmed when the instrument is in Diagnostic Mode. The nominal 1.7864 second scan interval is synchronized with the satellite motion so that the swaths of data taken on successive scans do not leave gaps in coverage on the Earth's surface. The nominal scan period is adjustable before launch by $\pm 1\%$.

The processed VIIRS data produce the EDRs shown in Table 4.1.1-1, VIIRS EDRs:

Table 4.1.1-1, VIIRS EDRs

Imagery
Sea Surface Temperature
Aerosol Optical Thickness
Aerosol Particle Size
Suspended Matter
Cloud Base Height
Cloud Cover/Layers
Cloud Effective Particle Size
Cloud Optical Thickness
Cloud Top Height
Cloud Top Pressure
Cloud Top Temperature
Albedo (surface)
Land Surface Temperature
Vegetation Index
Snow Cover
Surface Type
Ice Surface Temperature
Net Heat Flux
Ocean Color/Chlorophyll
Sea Ice Characterization
Soil Moisture

4.1.1.1 VIIRS Instrument Function

The many VIIRS hardware elements are grouped into a lesser number of functional subsystems for the purpose of overall operational control and data collection/generation by commands, telemetry, and packets. The goal of this partitioning into subsystems is

to focus on the end user operational interest, and may be tempered by interrelated control and support elements and quantity of major parameters. A subsystem may be a single circuit card assembly or several, a module, or a group of mechanical items.

Figure 4.1.1.1-1, shows the defined subsystems together with their 2-alpha identifiers (ID's); the IDs are given in Table 4.1.1.1-1, VIIRS 2-Alpha Subsystem IDs.

Table 4.1.1.1-1, VIIRS 2-Alpha Subsystem IDs

SC	Spacecraft (NPP or NPOESS)
AP	ASP - Analog Signal Processor & related FPA's
BB	OBB - Onboard Black Body
CP	Control Processor with common power block (1394, SBC, CTA, DPP & partial HMA)
CT *	CTA - Command & Telemetry Assembly
DP	DPP - Digital Preprocessor
EM *	Electronics Module
FT	FTC - Focal Plane Temperature Controller
HM	HMA - Heater & Mechanism Assembly
MF *	Mainframe
PS	Power Supply
SD	SDSM - Solar Diffuser Stability Monitor
SE	SCE - Servo Control Electronics & motors
* These subsystems only have telemetry items.	

The VIIRS images the scene with a Rotating Telescope and a rotating Half Angle Mirror (HAM), which together scan the field of view across the scene, followed by a stationary Aft Imager telescope and spectral separation optics that route segments of the electromagnetic spectrum through three paths to the Focal Planes.

The visible and near infrared portion of the spectrum (approximately 0.4 μm to 0.89 μm) is routed to a Visible and Near-Infrared Focal Plane Assembly (Vis/NIR FPA) with detectors for nine spectral bands. This optical path also illuminates the Day/Night Band (DNB) FPA that is located adjacent to the Vis/NIR FPA. The short-wavelength to mid-wavelength infrared (SWMWIR) portion of the spectrum (approximately 1.2 μm to 4.4 μm) is routed to a SWMWIR FPA with detectors for eight spectral bands. The long-wavelength infrared (LWIR) portion of the spectrum (approximately 8.4 μm to 12.5 μm) is routed to a LWIR FPA with five sets of detectors covering four spectral bands

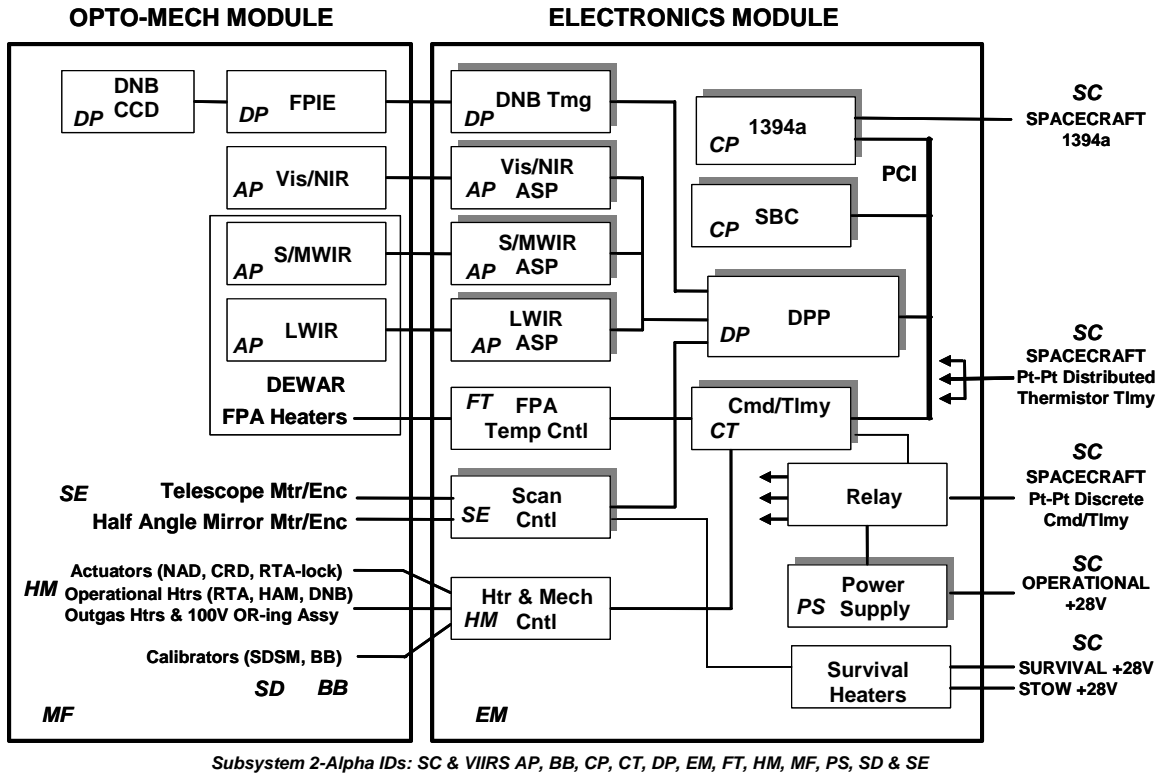

Figure 4.1.1.1-1, VIIRS Subsystem Overview with 2-alpha Ids

A passive Cryoradiator viewing deep space cools the SWMWIR and LWIR FPAs to enable low noise detection of the required wavelengths of infrared radiation.

In the VIIRS Electronics Module, the Analog Signal Processor (ASP or AP) read the measured scene radiances from the FPAs in analog form and process them until the Digital Preprocessor (DPP or DP) converts them to digital form. The Control Processor (CP) subsystem performs lossless entropy coding on the data, and formats the compressed data into CCSDS packets transmitted to the spacecraft via an IEEE 1394 interface. Much of the formatting process is performed by the reprogrammable VIIRS Single Board Computer (SBC).

In the VIIRS Electronics Module, the Command & Telemetry Assembly (CTA or CT) performs processing and execution of commands, control of temperatures within the sensor through the Focal Plane Temperature Controller (FT) and operation of all moving mechanisms. The SBC measures and formats the “engineering” and telemetry data necessary to verify the VIIRS sensor status and to process the VIIRS scene data.

Essentially all of the electronic circuits are redundant.

In each scan, VIIRS views two full-aperture on-board calibration sources and deep space in addition to the earth. The calibration sources include a Blackbody (BB) with accurately-known emissivity and temperature, and a Solar Diffuser (SD) that provides precisely-attenuated sunlight in the visible region of the spectrum. Since the diffusing surface of the SD may degrade slightly over time on orbit, the sensor also includes a Solar Diffuser Stability Monitor (SDSM) to detect changes in the SD's reflected radiance. SD and SDSM data is only valid during a one minute window each orbit that occurs near the Earth's south pole when the sun illuminates their respective input ports. The view of space prior to each scan acts as a known low-radiance source, and also provides occasional observations of the moon.

The VIIRS includes the following controllable mechanisms: (1) Rotating Telescope motor, (2) Half Angle Mirror motor, (3) a stepper motor that turns the three-position pointing mirror within the SDSM, (4) Nadir Aperture Doors (NAD), (5) Cryoradiator Door (CD), and (6) Rotating Telescope launch lock release mechanism. Once opened, the NAD and CD cannot be closed on orbit. The Rotating Telescope launch lock also cannot be reengaged on orbit once it has been released.

The two VIIRS Power Supplies (PS) provide power conditioning. Each has five sections, labeled A through E. When the VIIRS first turns On, Section_A is the only module that automatically comes On. The other sections are commanded On to support the particular sensor mode or activity.

The Heaters & Mechanism Assembly (HMA or HM) controls the heaters to activate the telescope launch locks and open the cryocooler and nadir aperture doors. It also maintains other components, including the cryocooler stages for outgassing, the blackbody calibrator, the DNB CCD and focal plane arrays, and the telescope and Half Angle Mirror motors.. Signal Processing Electronics: Electronics read the measured scene radiances from the Focal Plane Arrays (FPAs), perform lossless entropy coding on the data, and format the compressed data into CCSDS packets that are transmitted to the spacecraft via an IEEE 1394 interface.

4.1.1.2 VIIRS Instrument Modes

VIIRS has 9 Sensor Modes to support NPP and NPOESS mission operations. The modes and most common transitions are illustrated by Figure 4.1.1.2-1, VIIRS Mode Transitions. The spacecraft controls entry and exit of the first three modes. The remaining modes are established by a single bus Mode command, except for the Outgas Mode when the 100V Outgas PS's are not turned on until the transition configuration has been reached & verified.

Note, "Sensor Modes" is used as the modes title instead of "Operational Modes," in order not to cause interpretation conflict with the "OPERATIONAL DAY/NIGHT" mode.

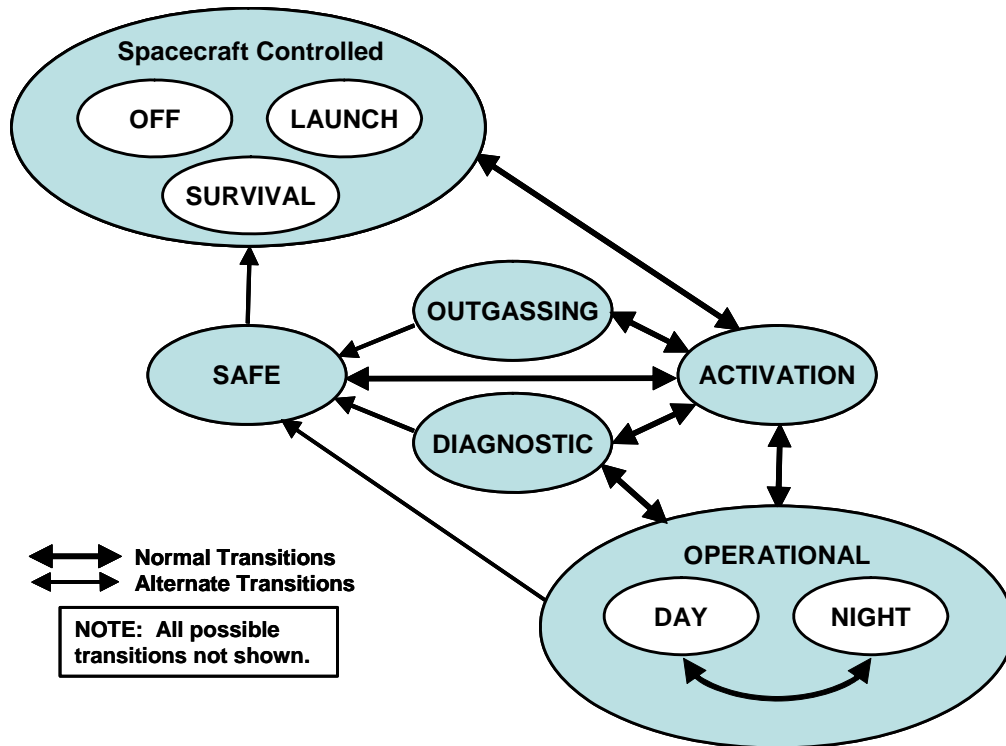

Figure 4.1.1.2-1, VIIRS Mode Transitions

Off Mode and Launch Mode: The VIIRS is in Off Mode when no external power is applied. The sensor performs no functions. The Launch mode describes the state of the VIIRS with nadir aperture and cryoradiator doors latched, launch locks applied and no power applied. Once activated after Launch Mode, the VIIRS is not expected to

transition to Off mode but may do so by removing all power.

Survival Mode: The VIIRS Survival Mode provides power to survival heaters sufficient to maintain a safe environment for the sensor. Otherwise, the mode is identical to Off Mode. No mission data is output.

Activation Mode: The VIIRS enters Activation Mode when power is initially applied or by command. The telescope does not rotate during Activation Mode so no Mission Data are output. Housekeeping telemetry is output to indicate the initial state of the sensor.

Outgassing Mode: The VIIRS sensor is placed into Outgassing Mode while the sensor is in Activation Mode by enabling the execution of outgas heater commands. This mode is used to decontaminate certain mechanical or optical elements of the sensor. Housekeeping telemetry is output but no mission data are, as the telescope remains in a stowed position.

Operational Mode: Operational mode is the normal operating condition for the sensor. It has two sub-modes for the day and night portions of the orbit. All data outputs are on, scene data and calibration source data are transmitted, and telemetry is monitored and transmitted. As the spacecraft moves through its orbit, commands stored in the Stored Command Orbit Table cause the VIIRS to switch between Operational/Night and Operational/Day sub-modes at the appropriate times. The VIIRS is commanded into Operational/Night mode when the sun angle is -3 degrees below the horizon for the entire scan; otherwise the VIIRS is commanded into Operational/Day mode. This Orbit Table will permit at least 60 days of autonomous operation.

The VIIRS outputs all spectral bands in Operational/Day mode. For the Day/Night Band (DNB), the gain stage appropriate for each sample is auto selected to pick the highest unsaturated gain stage (high, medium, or low gain stage). In Operational/Night Mode only 11 of its 22 spectral bands are transmitted. The VIIRS is also capable of transmitting the medium and low gain data from Stages 2 and 3 of the Day/Night Band CCD upon command. These data are formatted in the same manner as other DNB data but in separate APIDs (822 and 823). The normal Night mode data continues to be transmitted (APID 821). In all other ways, these two sub-modes are identical.

Transmitted DNB data from the high gain stage is generally the average of Stages 1A and 1B. In cases where outputs from 1A and 1B for a given sample differ by more than allowed for noise (e.g., in the SAA and elsewhere if a charged-particle hit corrupts one or the other high gain stage outputs), the output having the greater signal is rejected and the transmitted DNB data comes from the other (single) output, 1A or 1B, instead of from the average.

Diagnostic/Early Orbit Checkout Mode: Diagnostic/Early Orbit Checkout mode encompasses many sensor configurations necessary to support early post-launch checkout of the VIIRS, to support housekeeping and software updates, and to support trouble shooting by allowing different sampling of telemetry. Sensor data with little post-processing are output in a distinct set of APIDs from operational mode. The normal post-processing functions can be re-activated upon command.

Since the data format is complicated, test patterns can be enabled to fill the data output sequence with one or more chosen standard pixel sequences for each band, in place of the actual detector output data. The known sequence is sent along the sensor electronics, through the formatting, and on to the spacecraft. Ground analysts verify proper operation of the post-processing and formatting functions.

In the Diagnostic/Early Orbit Checkout mode, Dwell telemetry data packets can replace the normal telemetry packets upon command.

The VIIRS supports software modifications only in Diagnostic/Early Orbit Checkout Mode. Thus the Memory Dump packet will be output only in this mode.

Safe Mode: Under fault conditions sensed by the VIIRS or the spacecraft, the VIIRS turns off collection of science data and stows the telescope within 45 seconds. No mission data are output though housekeeping telemetry remains enabled.

4.1.1.3 VIIRS Data Type Mappings

Table 4.1.1.3-1, VIIRS Application Packet Types, presents a mapping of the VIIRS data types to the APID assignments. Additional data, such as availability, packet size, and frequency, is also provided.

Sensor data is collected from four views - Earth View, Space View, Solar Diffuser, and Blackbody. The VIIRS collects Earth view data over a field of view that is approximately +/- 56 degrees from nadir. The Earth view data is processed and downlinked in the Science Data packets. The Space View, Solar Diffuser View, and Blackbody View are collected to support instrument calibration and are downlinked in the Calibration Packet.

All SC-VIIRS 1394 bus data exchanges are via CCSDS packets. Packet formats comply with the formats described in this document. The secondary header timestamp represents the time at the start of a scan, except for Memory Dump packets where it represents the time the memory dump was generated. All fields are big endian.

Table 4.1.1.3-1, VIIRS Application Packet Types

CDFCB-X Section	Data Mnemonic Data Type	APID	Packet Type	Availability	Packet Size (octets)	Frequency (packets/sec)
4.1.2 HRD – Science	VI_NU-L00000-001	800 - 823	Science	Operational Mode	Varies	13.44 (24 packets / 1.7864 sec scan)
4.1.3 HRD - Calibration	VI_NU-L00000-002	825	Calibration	Operational Mode	Varies	.560 (One packet/1.7864 sec scan)
4.1.4 Engineering	VI_NU-L00000-003	826	HRD – Engineering	Operational Mode	9318	.560 (One packet/1.7864 sec scan)
		856	HRD – Diagnostic Engineering	Diagnostic Mode		
4.1.5 LRD – Science	VI_NU-L00000-004	1508-1529	Science	Operational Mode	Varies	13.44 (24 packets / 1.7864 sec scan)
4.1.6 HRD - Diagnostic Cal	VI_NU-L00000-005	855	Calibration	Diagnostic Mode	129,133	.560 (One packet/1.7864 sec scan)
4.1.7 HRD – Diagnostic	VI_NU-L00000-006	830 – 853	Diagnostic	Diagnostic Mode	Varies	13.44 (24 packets / 1.7864 sec scan)
4.1.8 Health & Status and Diagnostic Dwell	VI_NU-L00000-007	768	Health & Status	Operational Mode	446	.560 (One packet/1.7864 sec scan)
		773	Dwell	Diagnostic Mode		
4.1.9 Memory Dump	VI_NU-L00000-008	780	Memory Dump	Diagnostic Mode	Up to 4 Mega Octets	When commanded

4.1.2 High Rate Data (HRD) - Science

Data Mnemonic VI_NU-L00000-001

APID	APID	Band	Wavelength (μm)*	Night	Size(octets)
	800	M4	0.555	No	123,315
	801	M5	0.672	No	98,819
	802	M3	0.488	No	104,707
	803	M2	0.445	No	99,987
	804	M1	0.412	No	98,003
	805	M6	0.746	No	46,467
	806	M7	0.865	Yes	113,075
	807	M9	1.378	No	39,091
	808	M10	1.610	Yes	4,887
	809	M8	1.240	Yes	50,803
	810	M11	2.250	No	43,555
	811	M13	4.050	Yes	45,347
	812	M12	3.700	Yes	44,115
	813	I4	3.740	Yes	185,747
	814	M16**	12.013	Yes	35,747
	815	M15	10.763	Yes	49,907
	816	M14	8.550	Yes	33,299
	817	I5	11.450	Yes	194,227
	818	I1	0.640	No	195,795
	819	I2	0.865	No	164,307
	820	I3	1.610	No	193,555
	821	DNB	0.700	Yes	96,163
	822	DNBMGS	0.700	Yes	96,163
	823	DNBLGS	0.700	Yes	96,163

* Wavelength center frequencies are nominal.

** M16 is an average of two separate channels, M16a and M16b, which use the same frequency at different gain settings. The data in APID 814 can be selected to M16a, M16b, or the average.

M denotes that data for these bands is collected at moderate

resolution. "I" denotes that these bands are used for imaging and have higher resolution. The moderate resolution bands use 16 detectors and the imaging bands use 32 detectors. Some of the science application packets are only produced when the VIIRS is in Operational/Day mode. This is indicated by the Night column.

DNB Mid Gain Stage (DNBMGS) and DNB Low Gain Stage (DNBLGS) are sent rarely and only in night mode.

Description

The Science application packets contain Earth View pixel data for all 22 VIIRS channels. The 22 channels span the visible through infrared spectral regions. The 22 channels include 16 moderate resolution bands, 5 imaging resolution bands (which have twice the resolution of the moderate resolution channels), and one of three possible Day Night Bands (DNB). The DNB is designed to obtain imagery throughout both the day and night portions of the orbit. DNB APIDs 822 and 823, are enabled by a ground command.

The term pixel is used to denote the combining of samples through the aggregation process. The term sample is used to denote the output of one detector taken at a given instant in time. Samples are aggregated by zones. Samples taken near nadir have a 3:1 aggregation (i.e., three pixels equal one sample). Samples taken near the edge of scan have a 1:1 aggregation. Samples in between have a 2:1 aggregation. Aggregation is performed to minimize the pixel size variation and preserve the gain used to calibrate the pixels.

Additional processing is performed on the pixel data in the Science application packets. In addition to aggregation, spectral and/or spatial differential encoding, and lossless compression are performed Spectral and/or spatial differential encoding of the bands followed by lossless compression reduces the data rate.

Packet Size

Due to compression of the pixel data, the packet size varies. However, the first packet segment, including the primary and secondary headers, is 90 octets. The number of packet segments following the first segment is equal to the number of detectors for that band (either 16 or 32). These packet segments contain the pixel data for the six aggregation zones (three on each side of nadir).

Availability

All the science application packets, APIDs 800 through 823, are produced when the VIIRS instrument is in Operational Day Mode. However, only the science application packets, APIDs 806 (M7), 808 (M10), 809 (M8), 811 (M13), 812 (M12), 813 (I4), 814 (M16), 815 (M15), 816 (M14), 817 (I5), 821 (DNB), 822

(DNB), and 823 (DNB) are produced when the VIIRS instrument is in Operational Night Mode.

Day Night Band application packets (APIDs 822 and 823) are rarely transmitted and then only at night.

Frequency

Up to twenty-two APIDs, depending on day or night, are created and transmitted once for every scan, nominally every 1.7864 second. Each APID consists of segmented packets. There are 17 segmented packets for moderate resolution (M bands) and 33 segmented packets for imaging resolution (I bands), a 1st packet followed by a packet for each detector.

Data Content and Data Format

The science APIDs all have the same format. Each packet sequence contains one scan of data from one band formatted into grouped packets. Each science data group contains a first packet, followed by N-1 continuation packets, and a last packet, where N is the number of detectors associated with the band (16 or 32). The number of detectors is present in the Packet Sequence Count parameter in the Secondary Header of the first packet.

The first packet contains meta-data, including the number of pixels in the middle packets. The fields are shown in Figure 4.1.2-1, First Packet (metadata) in VIIRS Segmented Packet.

The middle and last packet segments contain the pixel data for each detector. The fields are shown in Figure 4.1.2-2, Middle Packets in VIIRS Segmented Packet. The number of segmented packets following the first (i.e., the number of middle and last segmented packets) is equal to the number of detectors for the band, and, consequently, for the APID. The last segment contains a packet sequence flag that indicates it is the last segment.

All data words are 15 bits in length.

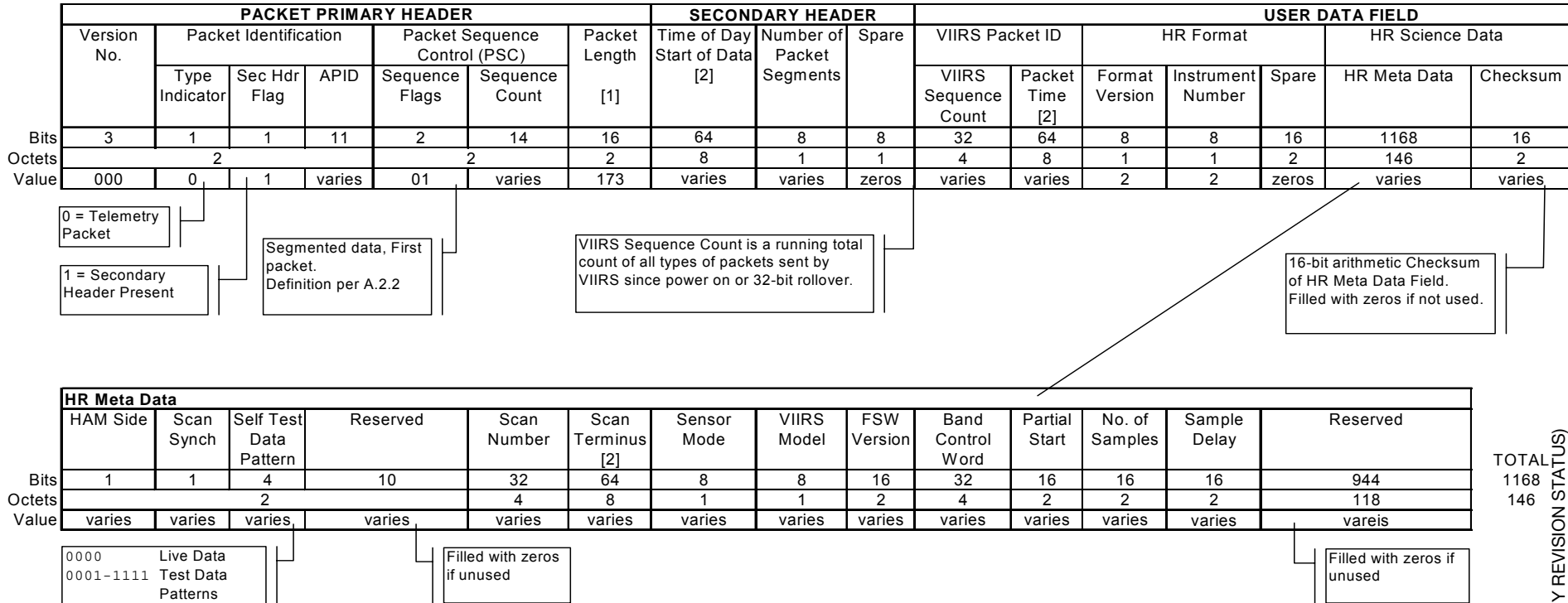

Notes:

[1] Packet length is the number of bytes after the primary header minus one.

[2] "Time of Day Start of Data", "Packet Time", and "Scan Terminus" fields are 64-bit CCSDS Day Segmented Time Code format as defined in CCSDS 301.0-B-2 (1958 January 1 epoch, 16-bit day, 32-bit msec, 16-bit usec). "Time of Day Start of Data" field is Start of Scan.

3. All packet fields are big endian.

Figure 4.1.2-1, First Packet (metadata) in VIIRS Segmented Packet

TOTAL
1168
146

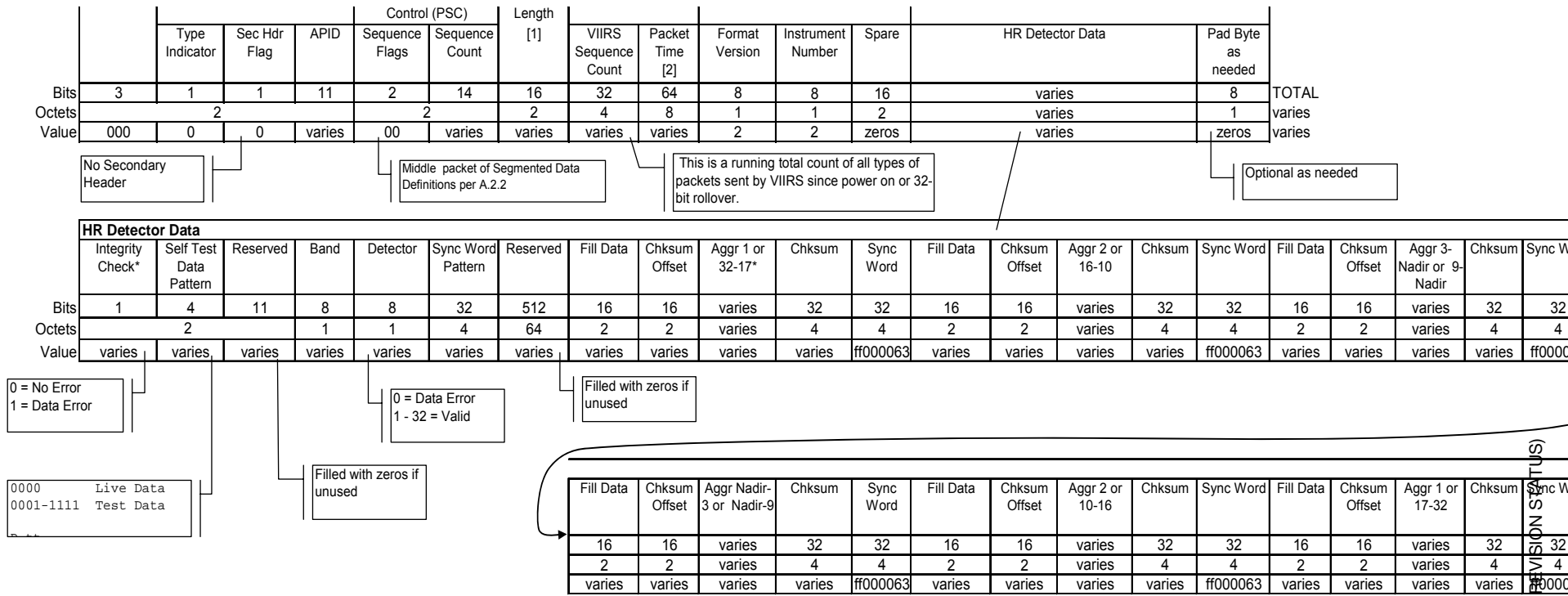

Notes:

- [1] Packet length is the number of bytes after the primary header minus one.
- [2] "Packet Time" field is 64-bit CCSDS Day Segmented Time Code format as defined in CCSDS 301.0-B-2 (1958 January 1 epoch, 16-bit day, 32-bit msec, 16-bit usec).
3. All packet fields are big endian.
4. Valid range for the detector field is 0-15 for Moderate Bands and 0-31 for Image Bands.
5. The 'checksum Offset' field consists of the size of the aggregation zone + 4 bytes to the checksum.

Figure 4.1.2-2, Middle Packet in VIIRS Segmented Packet

The VIIRS HRD Science Data consists of the 24 unique APIDs listed above output during Operational mode, with one APID for each of the five imaging and sixteen moderate resolution bands. The Day Night Band has 3 APIDs to identify three levels of gain settings. The low-gain packet is output for the full orbit and the packets medium and high gain outputs can be enabled during the night portion of the orbit.

Table 4.1.2-1, VIIRS Science Data Packet Band Information shows the instrument bands by type (e.g. visible, IR), by gain characteristics, and lists the predominant noise source for each band. A key element is the gain characteristics of each band (single or dual gain) because this defines other processing. . The M16 band uses time delay integration (TDI) of two sensors, M16A and M16B. Its data are sent as a single band in the science and diagnostic packets, but sent separately in the calibration packet.

Table 4.1.2-1, VIIRS Science Data Packet Band Information

	Band	λ	$\Delta\lambda$	Gain	Noise Source	Radiance
VIS	M1	0.412	0.020	Dual High	Photon	Reflective
		0.412	0.020	Low	Photon	
	M2	0.445	0.018	Dual High	Photon	Reflective
		0.445	0.018	Low	Photon	
	M3	0.488	0.020	Dual High	Photon	Reflective
		0.488	0.020	Low	ASP	
	M4	0.555	0.020	Dual High	Photon	Reflective
		0.555	0.020	Low	ASP	
	I1	0.640	0.080	Single	ASP	Reflective
	M5	0.672	0.020	Dual High	Photon	Reflective
0.672		0.020	Low	ASP		
M6	0.746	0.015	Single	Photon	Reflective	
NIR	I2	0.865	0.039	Single	Photon	Reflective
	M7*	0.865	0.039	Dual High	Photon	Reflective
		0.865	0.039	Low	ASP	
SWIR	M8*	1.240	0.020	Single	Detector	Reflective
	M9	1.378	0.015	Single	Detector	Reflective
	I3	1.610	0.060	Single	Detector	Reflective

	Band	λ	$\Delta\lambda$	Gain	Noise Source	Radiance
	M10*	1.610	0.060	Single	ASP	Reflective
	M11	2.250	0.050	Single	Detector	Reflective
MWIR	I4*	3.740	0.380	Single	Detector	Emissive
	M12*	3.700	0.180	Single	Detector	Emissive
	M13*	4.050	0.155	Dual High	Photon	Emissive
		4.050	0.155	Low	ASP	
LWIR	M14*	8.550	0.300	Single	Detector	Emissive
	M15*	10.763	1.000	Single	ASP	Emissive
	I5*	11.450	1.900	Single	Detector	Emissive
	M16*	12.013	0.950	Single	Detector	Emissive
	DNB*	0.7	0.4	Variable	Photon	Reflective

The science data Middle and Last packets contain subfields specifying the location of the first pixel (or sample) in the packet and the number of pixels (or samples) in the packet. This information is not needed when the instrument is in Operational mode. However, in Diagnostic mode each packet does not contain data corresponding to an entire scan so the location of the first pixel and number of pixels parameters are needed for displaying and interpreting the data in a packet.

All of the science APIDs have a common format. Each packet contains one scan of data from one band formatted into grouped packets. Each science data grouped packet consists of a First CCSDS Packet, N-1 Middle CCSDS Packets, and a Last CCSDS Packet, where N is the number of detectors associated with the band (16 or 32). The number of detectors is shown in Table 4.1.2-2, VIIRS Gain, Detector, & Bit Summary for Science Data, and is present in the Number_of_Packets parameter in the Secondary Header of the First packet. This table also summarizes the characteristics of the data words in each band. All data words are 15 bits in length, however the allocation of the bits between gain and data information depends on the band.

Table 4.1.2-2, VIIRS Gain, Detector, & Bit Summary for Science Data

[1] Band	[2] # of Zero Bits	[3] # of Gain Bits	[4] # of Bits for Data Number	[5] Total Number of Bits (15)	[6] # of Gain Settings	[7] # of Dets/Band	[8] # of Bits/Word
M1	2	1	12	15	2	16	13
M2	2	1	12	15	2	16	13
M3	2	1	12	15	2	16	13
M4	2	1	12	15	2	16	13
M5	2	1	12	15	2	16	13
M6	3	0	12	15	1	16	12
M7	2	1	12	15	2	16	13
M8	3	0	12	15	1	16	12
M9	3	0	12	15	1	16	12
M10	3	0	12	15	1	16	12
M11	3	0	12	15	1	16	12
M12	3	0	12	15	1	16	12
M13	2	1	12	15	2	16	13
M14	3	0	12	15	1	16	12
M15	3	0	12	15	1	16	12
M16	3	0	12	15	1	16	12
I1	3	0	12	15	1	32	12
I2	3	0	12	15	1	32	12
I3	3	0	12	15	1	32	12
I4	3	0	12	15	1	32	12
I5	3	0	12	15	1	32	12
DNB (stage1) Most sensitive (low rad/high gain)	0	1 (set "0")	14	15	NA	16	15
DNB (stage2) (med rad/med gain)	0	2 (set "10")	13	15	NA	16	15
DNB (stage3) Least sensitive (high rad/low gain)	0	2 (set "11")	13	15	NA	16	15
DNB MGS All data is med rad/med gain Apply Stage2	0	2 (set "10")	13	15	NA	16	15
DNB LGS All data is high rad/low gain Apply Stage 3	0	2 (set "11")	13	15	NA	16	15

Notes: [8] indicates meaningful band bits before compression & after ground data recovery. For the dual gain bands (bold in the table), the following logic applies to the gain bit. If the gain bit == 0, this is a HIGH State. If the gain bit == 1, this is a LOW State. All DNB bands above Stage 1 are the most significant bit of the 14 bit value.

To meet the requirements for EDR products, accommodate S/C downlink bandwidth limitations, and compensate for artifacts arising from the scan geometry over the Earth's surface, several types of on-board processing are performed by the instrument electronics or the VIIRS Auxilliary Processor (VAP) in the spacecraft PSP. Figure 4.1.2-

3, VIIRS Scanning Geometry for Science Data shows the artifacts of the scanning geometry.

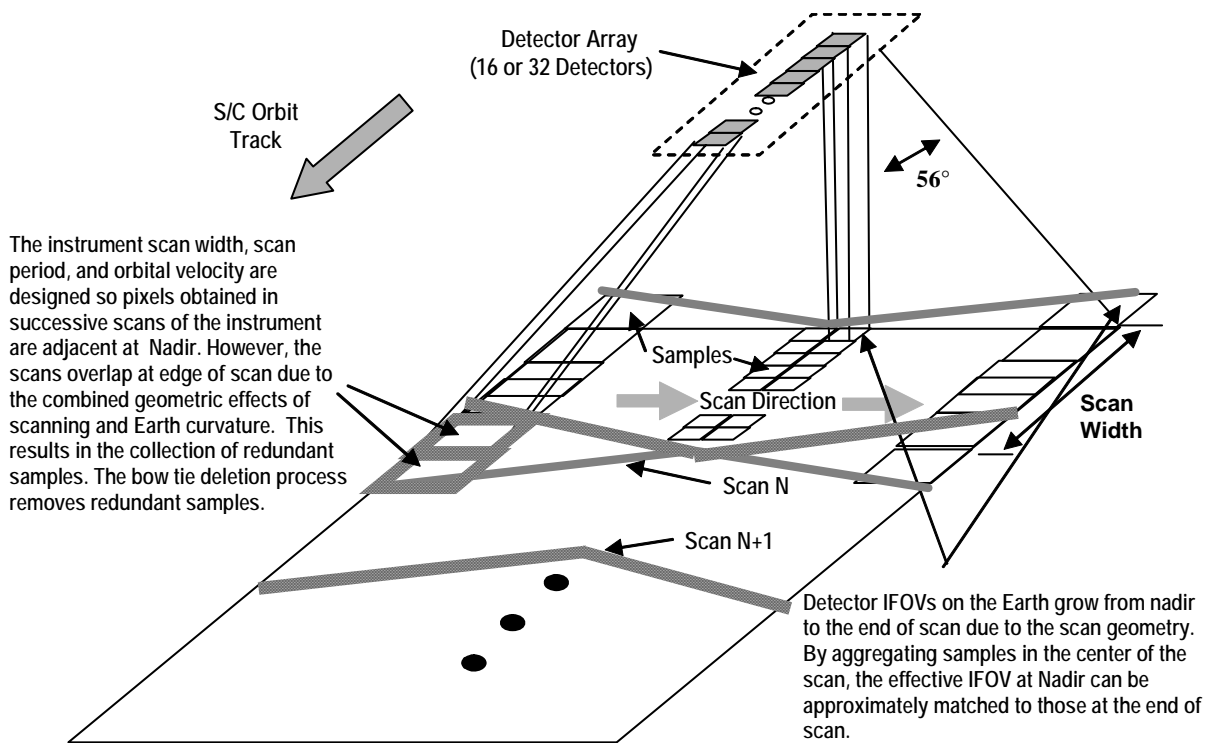

Figure 4.1.2-3, VIIRS Scanning Geometry for Science Data

Bow Tie Deletion is disabled on the VIIRS instrument for NPOESS, but is instead performed in the PSP by the VAP. This processing eliminates redundant data at the edges of successive scans to reduce the amount of data. Sample aggregation, the combining of adjacent samples along a scan, reduces overall bandwidth, is done by the instrument; this improves SNR, and matches the IFOV footprints of samples across the scan. Spectral and/or spatial differential encoding of the bands followed by lossless compression is done by the VIIRS instrument to reduce the data rate (This is not shown in the figure.).

There are two instrument modes which send scanning data - Operational and Diagnostic. The latter is provided for early orbit support, anomaly resolution and test. In Operational Mode the instrument performs the processing indicated above - Aggregation, and Lossless Compression. In Diagnostic Mode, all of these processing functions are disabled. Additionally operators control the width of the effective scan, and

thus the amount of data collected per scan, and/or the number of bands actually packetized and downlinked. This enables the downlink bandwidth constraints to be met in Diagnostic Mode.

The Day Night Band processing differs from that described above in several respects. Bow-tie deletion is not performed for the Day Night Band in a way that is identifiable at the packet level. Rather than by post processing, the DNB inherently aggregates the CCD data on both sides of Nadir during data collection by a series of sample timing steps. At the packet level the DNB samples are organized into 6 aggregation zones, so they resemble the other bands; however the aggregation of the DNB samples is performed differently from the other bands as just indicated. Compression is performed on the DNB data in each of the aggregation zones at the packet level.

The term Sample is used to denote the output of one detector taken at a given instant of time. When Samples are combined in the aggregation process the term Pixel is used to denote the result. This nomenclature is consistent at the packet level. However, it should be noted that if the data is being described at a lower level these definitions require some qualification, especially for the DNB.

A functional overview of the on-board processing performed in Operational Mode is shown in Figure 4.1.2-4, VIIRS Overview of Science Data Processing in Operational Mode.. Moderate resolution and imaging bands undergo sample aggregation, spectral or spatial differential encoding, and compression. Arithmetic processing is performed prior to differential encoding to ensure that the differential encoding process does not result in negative numbers. For dual gain bands, additional processing is performed to incorporate data on the gain state into the data words. After unique aggregation (described below), DNB data is compressed like the other bands.

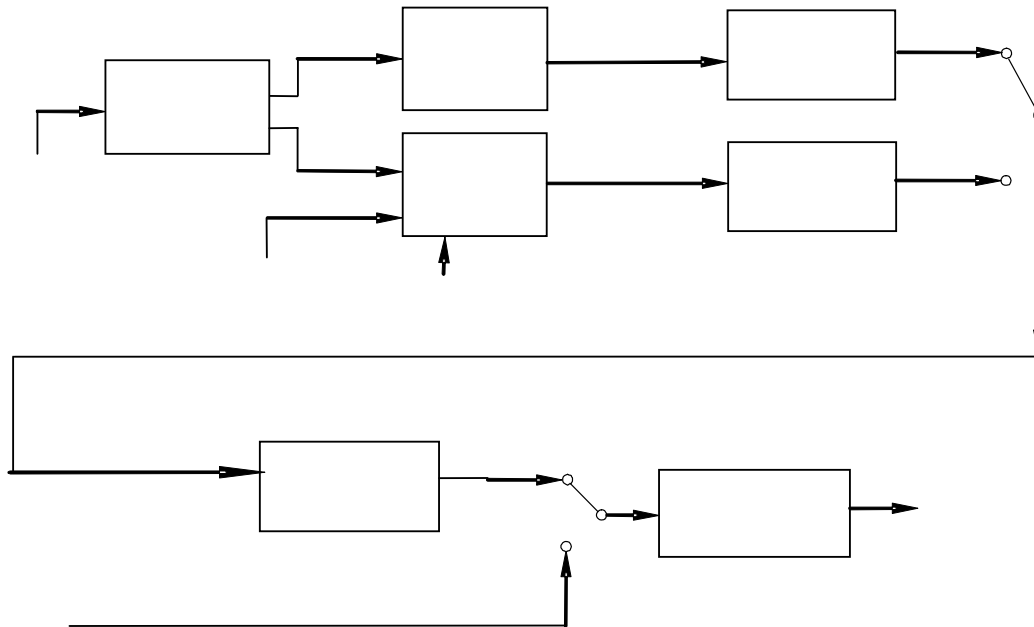

Figure 4.1.2-4, VIIRS Overview of Science Data Processing in Operational Mode

4.1.2.1 Operational Mode Aggregation

Sample aggregation is performed on the single gain bands. Samples are aggregated 3:1, 2:1, or 1:1 to form Pixels. The amount of aggregation is a function of their location in the scan, with 3:1 aggregation occurring in the middle of the scan and 1:1 (no) aggregation occurring at the edges. The regions over which aggregation is performed are called Aggregation Zones.

Figure 4.1.2.1-1, VIIRS Overview of Aggregation for Single Gain/Imaging HRD – Operational Mode illustrates the aggregation process and the formation of aggregation zones for single gain and imaging bands. Although the number of detectors and pixels vary, the aggregation process is the same for the moderate resolution single gain bands and the single gain imaging bands. Figure 4.1.2.1-2, VIIRS Aggregation Zone Definition, shows the boundaries and sizes of the aggregation zones and the along-scan resolution that results after aggregation of the single gain bands. Although no aggregation is actually performed on the dual gain band data, it is grouped into six “aggregation zones” for purposes of spectral differencing and compression. Thus when viewed at the packet level, the data from dual gain bands looks very similar to that from single gain bands.

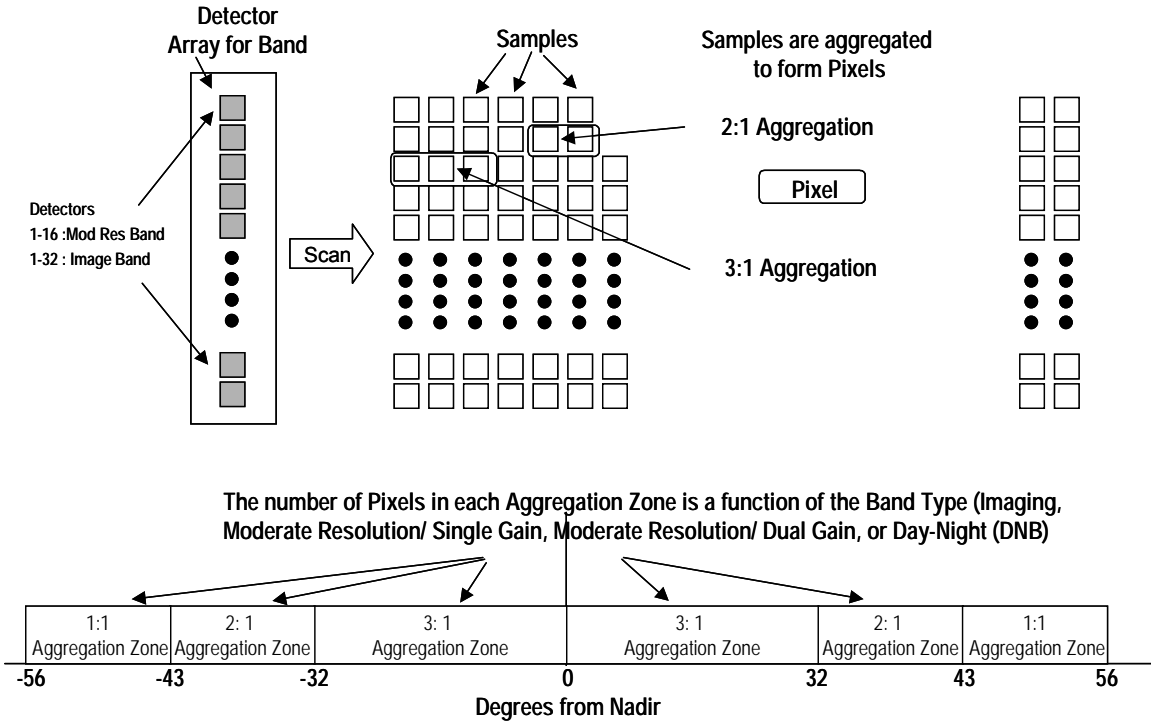

Figure 4.1.2.1-1, VIIRS Aggregation for Single Gain/Imaging HRD – Operational Mode

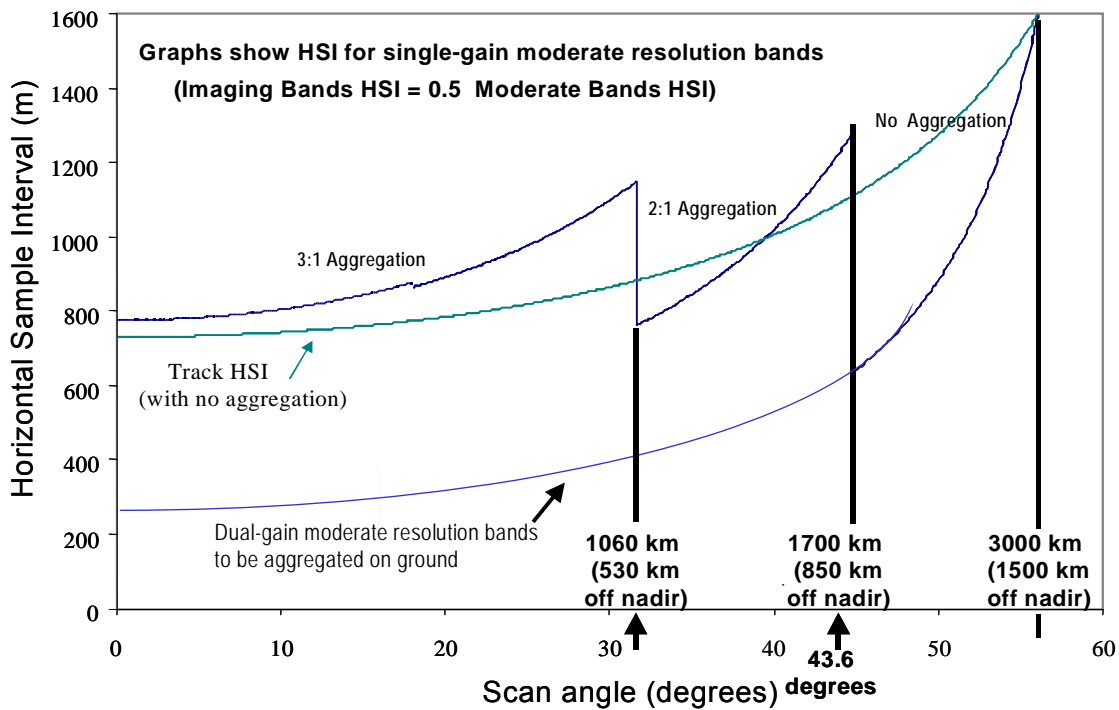

Figure 4.1.2.1-2, VIIRS Overview of Aggregation Zone Definition

4.1.2.2 Operational Mode Bow Tie Deletion in the VAP

Bow -tie deletion is applied to all imaging and moderate resolution bands for the entire scan, irrespective of their gain characteristics. There is no bow-tie deletion required for DNB band data.

The following figures, Figure 4.1.2.2-1, Bow-Tie Deletion for Moderate Resolution Bands, and Figure 4.1.2.2-2, Bow-tie Deletion for Imagery Bands, identify the aggregation zones that need to be bow-tie deleted.

	Aggregation zone #1	Aggregation zone #2	Aggregation zone #3	Aggregation zone #4	Aggregation zone #5	Aggregation zone #6
1	Bow tie zone	Bow tie zone			Bow tie zone	Bow tie zone
2	Bow tie zone					Bow tie zone
3						
4						
⋮						
13						
14						
15	Bow tie zone					Bow tie zone
L	Bow tie zone	Bow tie zone			Bow tie zone	Bow tie zone

Figure 4.1.2.2-1, Bow-tie Deletion for Moderate Resolution Bands

	Aggregation zone #1	Aggregation zone #2	Aggregation zone #3	Aggregation zone #4	Aggregation zone #5	Aggregation zone #6
1	Bow tie zone	Bow tie zone			Bow tie zone	Bow tie zone
2	Bow tie zone	Bow tie zone			Bow tie zone	Bow tie zone
3	Bow tie zone					Bow tie zone
4	Bow tie zone					Bow tie zone
5						
⋮						
28						
29	Bow tie zone					Bow tie zone
30	Bow tie zone					Bow tie zone
31	Bow tie zone	Bow tie zone			Bow tie zone	Bow tie zone
L	Bow tie zone	Bow tie zone			Bow tie zone	Bow tie zone

Figure 4.1.2.2-2, Bow-tie Deletion for Imagery bands

During the bow-tie deletion process, data in the aggregation zones identified as bow-tie zones is replaced by a fixed pattern “0000 0800” hex. The VAP then updates the CCSDS packet header and data zone of the affected packets. All primary headers are

updated with the resulting packet length values. For each deleted aggregation zone these data fields are updated as follows:

Checksum Offset	Data replaced with 0x0008
Checksum	Data replaced with 0x0000 0800
Fill Data	Data replaced with 0x0400

4.1.2.3 Operational Mode Differential Coding & Compression

Differential encoding is performed between bands prior to compression to further reduce the amount of data. The rationale for the selection and ordering of bands for differential encoding are not presented here. Table 4.1.2.3-1, VIIRS Science Data Packet Band Transmission & Processing Order .shows the band prediction table for differentially encoding the bands. For reference, this table also shows information about each of the bands, including whether they are collected at night, and key optical parameters. The table also shows the recommended transmission order of the bands. While this order is not obligatory, if the bands are transmitted in the sequence shown, ground processing and storage can be minimized.

Table 4.1.2.3-2, VIIRS Processing Summary for Differential Encoding, shows the processing functions that are implemented inside the “Processing for Differential Encoding” box in Figure 4.1.2-2, VIIRS Overview of Science Data Processing in Operational Mode, as a function of band. Note the relation of the A, B & C points.

Table 4.1.2.3-1, VIIRS Science Data Packet Band Transmission & Processing Order

Processing and Transmission Sequence	Encoded Band	Night	Wavelength (µm)	Bandwidth (µm)	Predictor Band	Wavelength (µm)	Bandwidth (µm)
1	M4	No	0.555	0.02	NONE		
2	M5	No	0.672	0.02	M4	0.555	0.02
3	M3	No	0.488	0.02	M4	0.555	0.02
4	M2	No	0.445	0.018	M3	0.488	0.02
5	M1	No	0.41	0.02	M2	0.445	0.018
6	M6	No	0.746	0.015	NONE		
7	M7	Yes	0.865	0.039	NONE		

Processing and Transmission Sequence	Encoded Band	Night	Wavelength (μm)	Bandwidth (μm)	Predictor Band	Wavelength (μm)	Bandwidth (μm)
8	M9	No	1.378	0.015	NONE		
9	M10	Yes	1.61	0.06	NONE		
10	M8	Yes	1.24	0.02	M10	1.61	0.06
11	M11	No	2.25	0.05	M10	1.61	0.06
12	M13	Yes	4.05	0.155	NONE		
13	M12	Yes	3.7	0.18	NONE	4.05	0.155
14	I4	Yes	3.74	0.038	M12	3.7	0.18
15	M16	Yes	12.01	0.95	NONE		
16	M15	Yes	10.7625	1.00	NONE		
17	M14	Yes	9.55	0.30	M15	10.7625	1.00
18	I5	Yes	11.45	1.90	M15	10.7625	1.00
19	I1	No	0.64	0.08	NONE		
20	I2	No	0.865	0.039	I1	0.64	0.08
21	I3	No	1.61	0.06	I2	0.865	0.039
22	DNB	Yes	0.70	0.40	NONE		

Table 4.1.2.3-2, VIIRS Processing Summary for Differential Encoding

Band(s)	A (14 bits)	B (14 bits)	C (15 bits)
M16	M16A	M16B	$C = (A + B)/2 + \text{L.E. zero}$
Dual gain (Non-Pred)	$2^{14}-1$	Data + $(2^{14}-1)$	$C = B - A + \text{L.E. zero}$
Dual gain (Pred)	Pred (Ref Band)	Data + $(2^{14}-1)$	$C = B - A + \text{L.E. zero}$
Single gain (Non-Pred)	$2^{14}-1$ (14 bits)	Data + $(2^{14}-1)$	$C = B - A + \text{L.E. zero}$
Single gain (Pred)	Pred (Ref Band)	Data + $(2^{14}-1)$	$C = B - A + \text{L.E. zero}$

Lossless compression is performed on the data from all science data bands. Note that for some bands, the actual band data is compressed; for others differential data is compressed. Data is compressed by aggregation zone. Thus, since there are 6 aggregation zones per scan, there will be 6 sets of compressed data per scan for each detector. Table 4.1.2.3-3, VIIRS USES Compression Information shows the Universal Source Encoder for Space (USES) compression algorithm parameters that are used to

process the data.

Table 4.1.2.3-3, VIIRS USES Compression Information

USES Parameter	Value	Units
J	8	Samples per block
N	15	Bits per sample
Mode	Nearest neighbor	-
BlkRef	128	Blocks per reference

Figure 4.1.2.3-1, VIIRS Band Reconstruction Diagram, shows the flow diagram for reconstructing the bands from the transmitted differential values. For reference, VIIRS band processing flow bands processed at night are shaded. The band reconstruction process is the same for day and night however.

There is one subtlety of the reconstruction process that is not clearly shown in the figure. This is the processing required when a moderate resolution band is used to reconstruct an imaging band. This is accomplished by “reusing” one moderate resolution band sample to reconstruct four nearest neighbor samples of the imaging band as shown in Figure 4.1.2.3-2, VIIRS Reconstruction of Imaging Bands with Moderate Resolution Bands as Predictors.

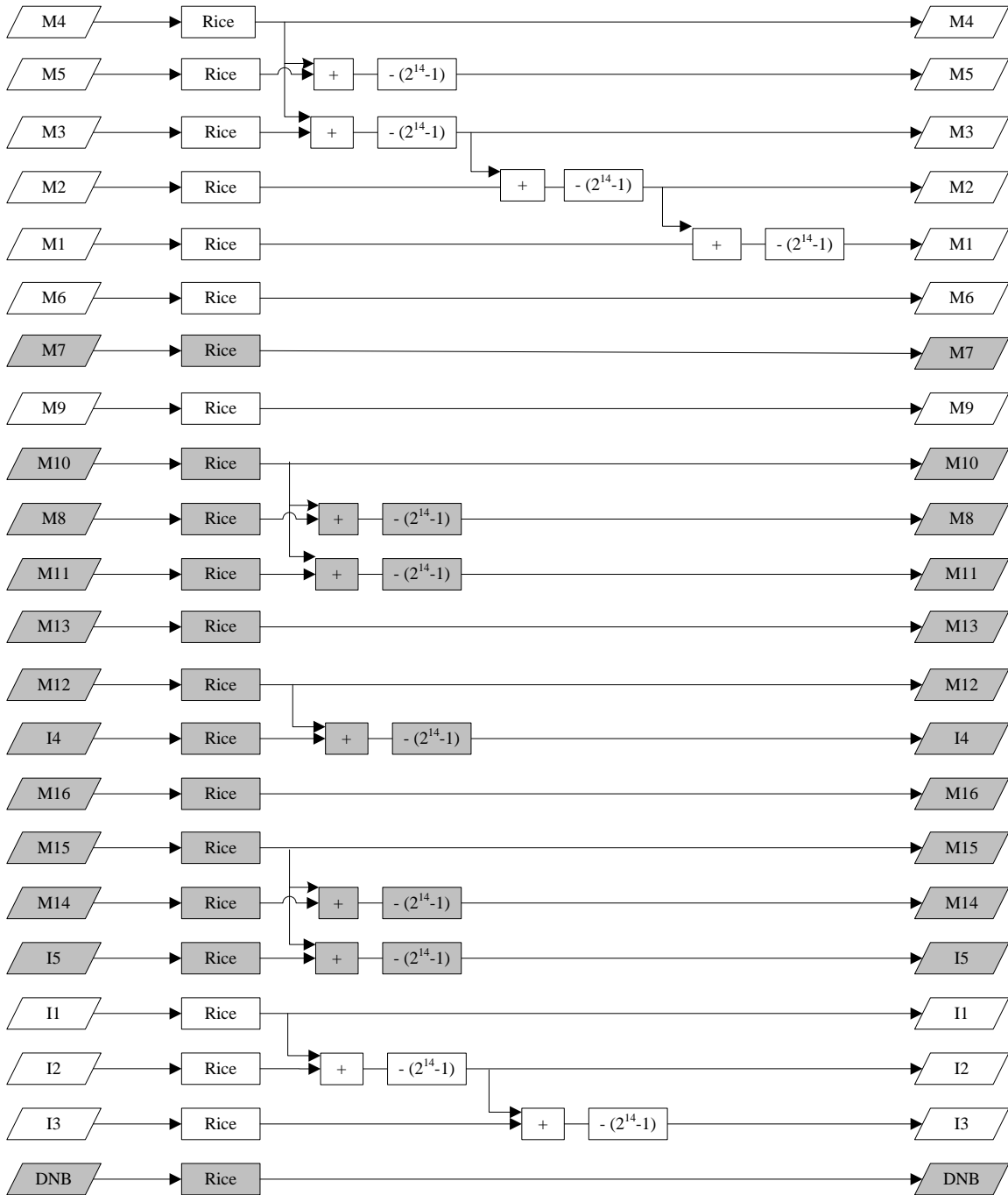

Figure 4.1.2.3-1, VIIRS Band Reconstruction Diagram

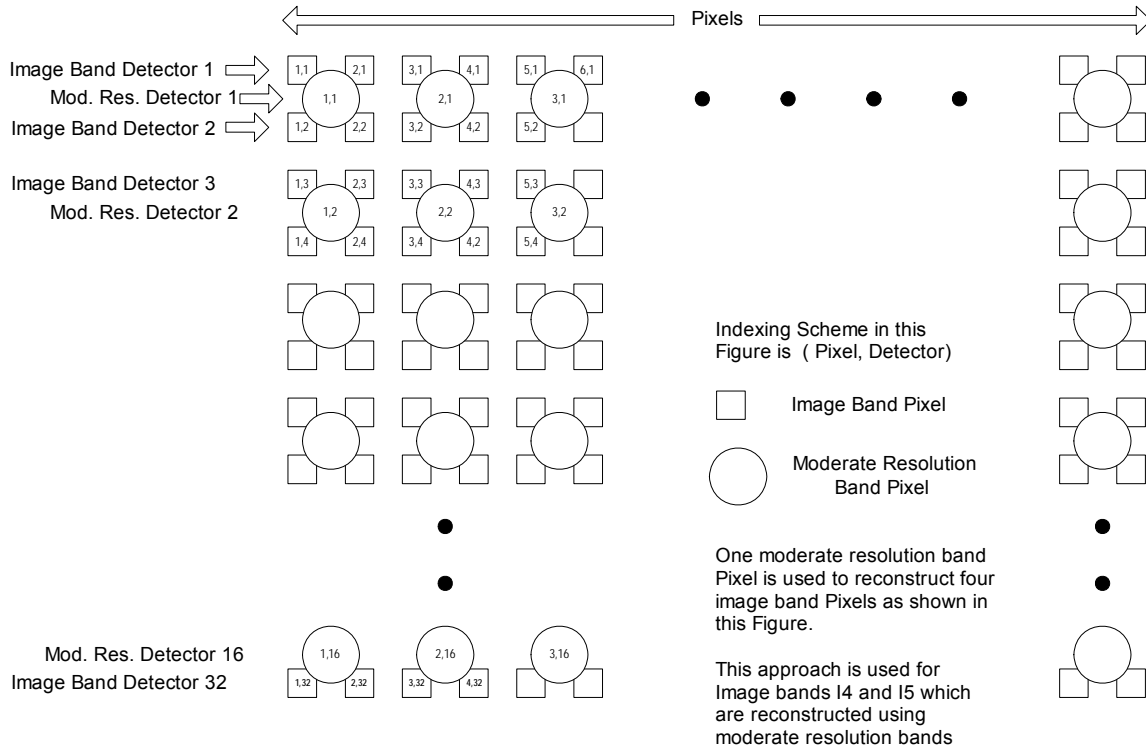

Figure 4.1.2.3-2, VIIRS Reconstruction of Imaging Bands with Moderate Resolution Bands as Predictors

4.1.2.4 Operational Mode Arithmetic Operations

In addition to aggregation and bow tie deletion, Figure 4.1.2-2, VIIRS Overview of Science Data Processing in Operational Mode (above) also shows arithmetic operations associated with the processing of science data. The digital data representing single-gain spectral bands are processed differently from dual-gain band data. The first step for both types is to convert the 2's complement numbers into 14-bit straight binary form.

After aggregation, the single gain band 16 bit words are then truncated to 12 bits and two leading-edge zeros are added, giving 14-bit binary values, which are input to the differential encoding and compression functions.

After conversion from 2's complement form to straight binary, the data from dual-gain spectral bands are merged with the stream of "gain bits" from the focal plane array (FPA) that indicate whether each sample was taken in the high or low gain state. The

gain bit is appended as a Most Significant Bit (MSB) to the beginning of each data word, yielding a 15-bit binary value. This has the effect of creating a discontinuous piecewise-linear relationship between radiance and the digital value. Because the discontinuity would reduce the efficiency of the subsequent data compression process, a constant is then subtracted from all the data words in the upper portion of the radiance range. This discontinuity constant is subtracted from dual-gain detector outputs in calibration mode. The value subtracted for each spectral band, one of seven in the Discontinuity Offset Registers referred to in the Band Control Word of the first packet, does not totally eliminate the discontinuity, but does reduce its magnitude. The seven constant values subtracted are stored in the uploadable/downloadable DPP Register Initialization Table (VIIRS Table ID 7). The constants are available on the MSD sever. Figure 4.1.2.4-1, VIIRS Piecewise Linear Function Resulting From Dual Gain Processing, graphically shows the piecewise linear function that results from gain changes in the dual gain bands. The term DN (Digital Number) used in the figure refers to the binary value of the data.

The 15-bit data values are then truncated to 13 bits, so that both single- and dual-gain band data is passed to the differential encoding (described above) and compression functions as 14-bit binary words.

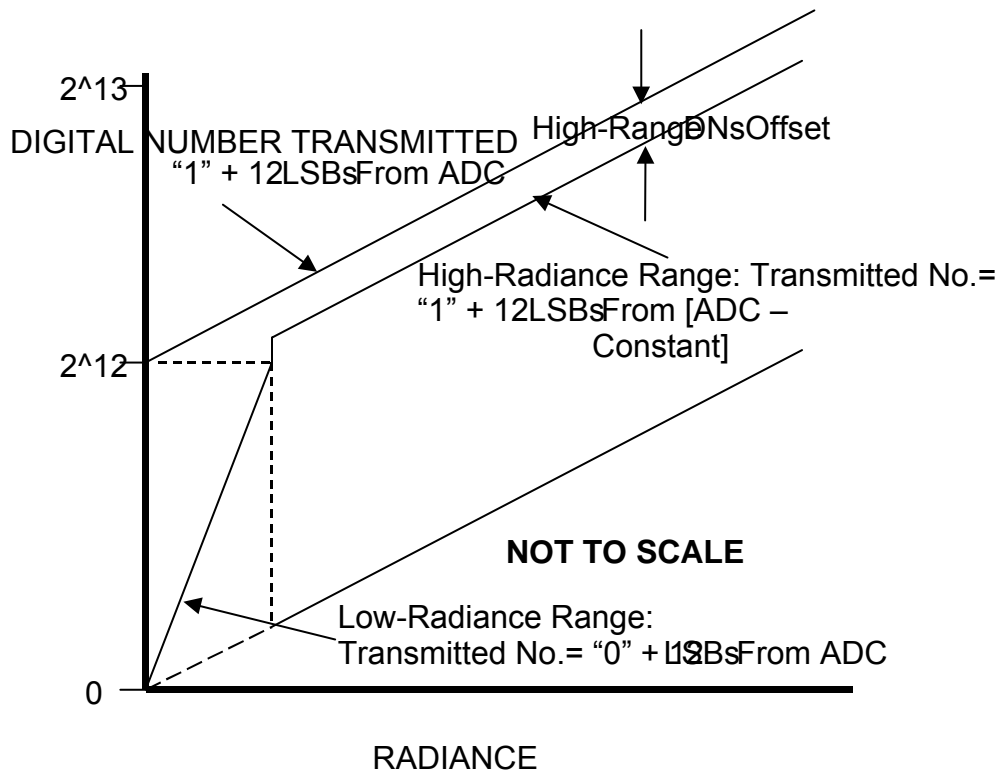

Figure 4.1.2.4-1, VIIRS Piecewise Linear Function Resulting From Dual Gain Processing

4.1.2.5 Operational Mode Packet Processing

As mentioned, there is one grouped science data packet per band. The first CCSDS packet of the group contains meta-data characterizing the scan and band. Its Secondary header indicates the number of packet to follow, equal to the number of detectors in the band. The Middle and Last science data CCSDS packets contain 6 subfields of data each containing the compressed pixels from one of the 6 aggregation zones associated with a scan. These data subfields are denoted as "Aggr N" on the packet diagrams.

After compression, as part of the processing to build the above subfields, 1 to 31 bits having value 0 are appended to the compressed data to make the total length of the compressed "Aggr N" subfield a multiple of 32 bits. The number of bits appended can be determined by using the "Fill Data Word" in the HRD middle and last packets. Prior to decompression, the appended bits must be removed from the data or the

decompression will be incorrect. The length of the “Aggr N” zone is determined by the Checksum Offset field, immediately preceding the “Aggr N” data. Checksum and Sync Word fields follow each “Aggr N” zone. These five fields repeat six times in each Middle and Last of the grouped science packets. The value in the checksum offset field is always equal to the length of the aggregation field in bytes, plus 4.

For the special case of bowtie deletion, the checksum offset field contains the value 8, namely, the 4 bytes representing the empty aggregation field, plus 4.

The process for extracting data from the HRD packets when the instrument is in Operational Mode is shown in Figure 4.1.2.5-1, VIIRS Flow for Extraction of Operational Mode Data from Science Data.

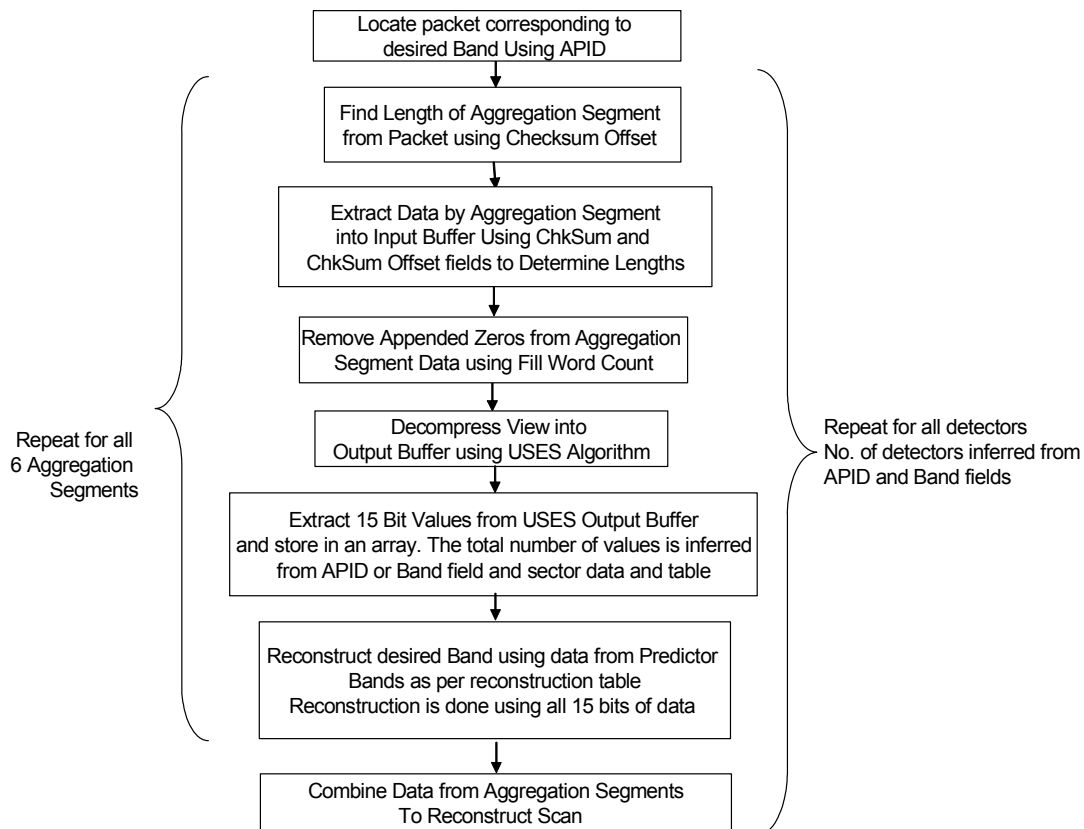

Figure 4.1.2.5-2, VIIRS Flow for Extraction of Operational Mode Data from Science Data

4.1.2.6 Day/Night Band Processing

Although there are significant differences between the DNB and the other bands at the lowest levels of the instrument (focal plane, sub pixel, and front-end electronics), at the packet level, the DNB is actually very similar to the other bands. DNB data are output in APIDs 821-823. The three APIDs correspond to different gain settings of the 16 DNB detectors. The output pixels from each detector corresponding to a scan are placed in a grouped packet that has the same structure as the science data packets for the other bands.

The number of DNB pixels per scan in Operational Mode is equal to 4064. A scan is broken up into six “aggregation” zones as is done for the other bands. The lengths of the aggregation zones, shown in Figure 4.1.2.6-1, VIIRS Packet Structure & Definition of terms for Day Night Band (DNB) – Operational Mode, are unique to the DNB. In Operational mode, the pixels within an aggregation segment are compressed in the same manner as described for the other bands. Although it is not relevant to processing the packets, for completeness shows how the six aggregation zones are actually formed from 32 lower-level aggregation zones. The lengths of these lower level zones are determined by the geometry of the DNB focal plane array and parameters including SNR and illumination range. The data used to form the 32 lower level zones are not accessible at the packet level.

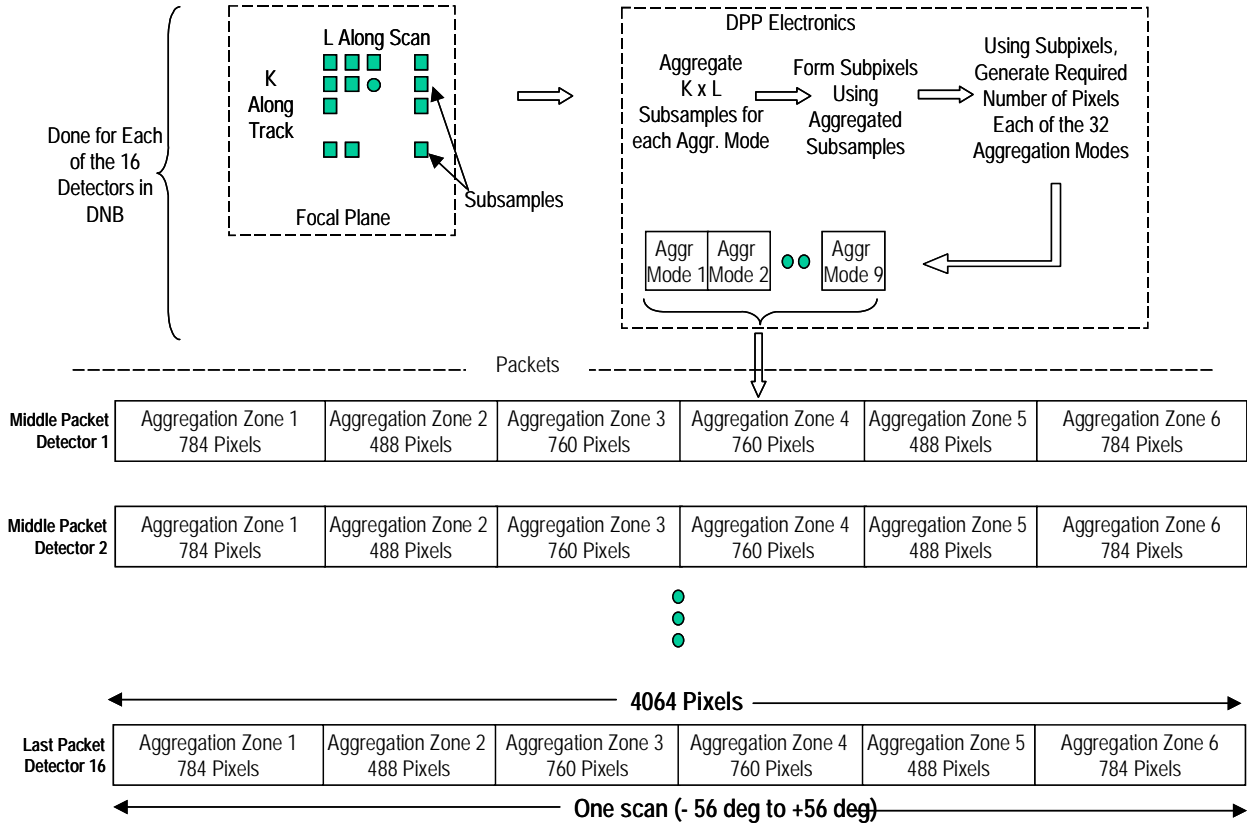

Figure 4.1.2.6-1, VIIRS Packet Structure & Definition of terms for DNB – Operational Mode

Figure 4.1.2.6-2, VIIRS DNB processing flow – Operational Mode, shows, at a top level, the processing for DNB data when the instrument is in Operational Mode.

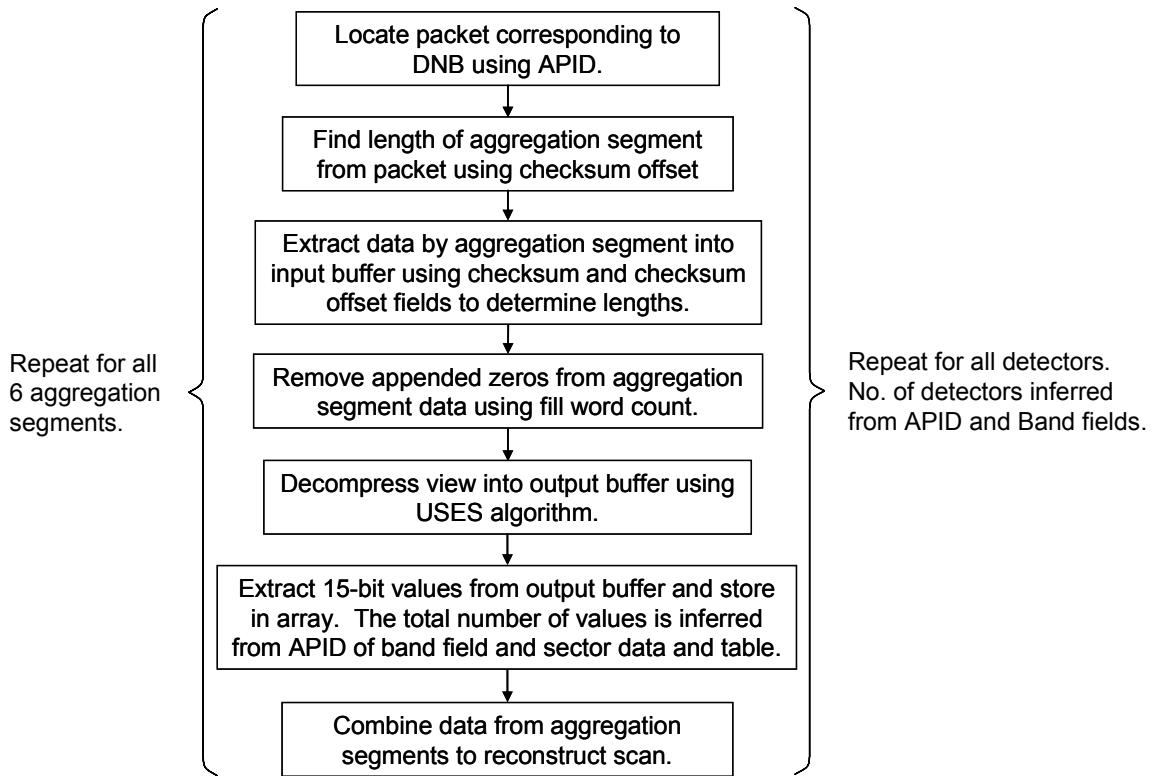

Figure 4.1.2.6-2, VIIRS DNB Processing Flow – Operational Mode

4.1.3 High Rate Data (HRD) - Calibration

Data Mnemonic	VI_NU-L00000-002
APID	825 HRD Calibration
Description	The top-level organization of the Calibration Packet is similar to the HRD packets. The Calibration Packet is a Consultative Committee on Space Data Systems (CCSDS) segmented packet that contains all the Calibration data for all bands. The first packet in the segmented packet contains metadata. The 21 Middle packets and the one Last packet each contain the calibration data for one of the 22 bands. The packet contains data from 16 or 32 detectors per band, viewing all three calibration sources (space view, solar diffuser view, and blackbody view). Regardless of whether VIIRS is in the day or night portion of its orbit, the calibration packet is the same.
Packet Size	Due to Rice compression of the pixel data, the packet size varies. The <i>uncompressed</i> packet would be 188,806 octets in night mode. The first packet segment is 168 octets. There are 22 segmented packets following the first segmented packet, one for each band. Each of these segmented packets contains the radiance data for the space, blackbody, and solar diffuser views for all of the detectors (16 or 32) for each band.
Availability	The HRD Calibration application packet, APID 825, is produced when the VIIRS instrument is in Operational Day and Operational Night Modes.
Frequency	The HRD Calibration packet is created and transmitted once for every 1.7864 second scan. It contains 23 segmented packets, each with calibration data for all 22 bands, as explained in the Description field above.
Data Content and Data Format	The calibration data consists of 15 bit words, with a leading (MSB) zero bit followed by 14 bits of data. The data is ordered by detector; for each detector the view order is Space, Blackbody, and Solar Diffuser. The view data is compressed, and zeros are appended making the length of each view field a multiple of 32.

An overview of the organization of the Calibration packet is shown in the Figure 4.1.3-1, VIIRS Format of Detector Data Field in Calibration Packet – Diagnostic Mode.

Regardless of whether VIIRS is in the day or night portion of its orbit, the calibration packet format is the same. The only difference between day and night mode band content is that two day mode Moderate bands (M4 and M5) are replaced with Mid and

Low Gain DNB Stages (DNBMGS and DNBLGS) in night mode. Bands M16A and M16B are both transmitted as separate bands (without TDI) in the calibration packets for all operating modes. See Table 4.1.3-1, VIIRS Gain, Detector, & Bit Summary for Calibration Data.

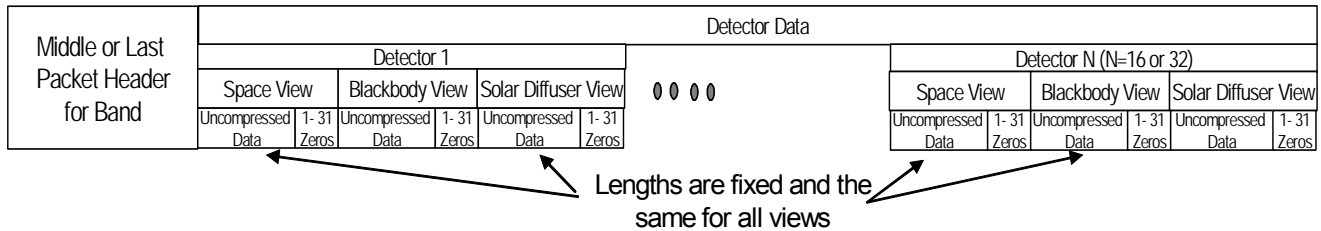

Figure 4.1.3-1, VIIRS Format of Detector Data Field in Calibration Packet – Diagnostic Mode

Within a middle or last CCSDS packet the data is ordered by detector and, then by view (Space, Blackbody, or Solar Diffuser) as shown in the figure. The length of all views for moderate bands is 48 samples, imaging bands is 96. The DNB calibration data consists of 16 samples from each of the four gain stages, making a total of 64 samples in each view. The order of the DNB stages in the packet is HGA, HGB, MGS, LGS. If the DNB is in aggregation mode 35 or 36, then only 4 samples are reported in each stage for a total of 16 samples per view. There is no specific telemetry point that identifies what DNB aggregation mode is being transmitted in calibration view. Aggregation modes 35 and 36 send only 16 samples of data and can be used to sync the processing to where the VIIRS system is in the aggregation mode sequence. The sample length of all views is fixed and not programmable in software. The calibration view data (SV, BB, SD) have 14 significant bits preceded by a MSB of zero for 15 bits per sample. The value in the checksum offset field is equal to the length of the corresponding view field in bytes, plus 4.

When the instrument is in Operational Mode, the samples representing the output from each view are compressed as individual blocks of data using the USES algorithm. The details of compression and decompression of calibration data are essentially the same as for the science data packet; compression is performed at the view level, as shown in Figure 4.1.3-2, VIIRS Calibration Data Packet Structure, and Figure 4.1.3-3, VIIRS

Format of Detector Field in Calibration Packet – Operational Mode. After each view is compressed, zeroes are appended to make the length of the compressed data a multiple of 32. Before decompression, these appended zeros must be removed. The Number of Fill Bits field associated with each view contains the number of zeros appended to the data after compression.

Calibration Packet is a CCSDS Segmented Packet Whose Structure is Similar to HRD Packets, Except Middle and Last Packets are Organized by Band (vs. Detector for HRD)

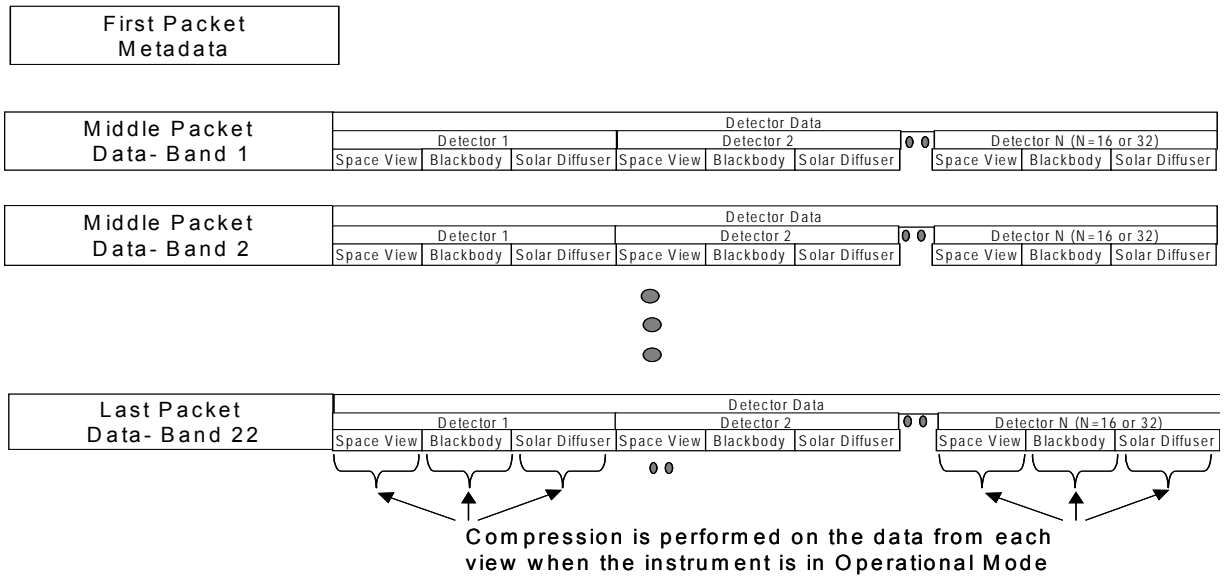

Figure 4.1.3-2, VIIRS Calibration Data Packet Structure

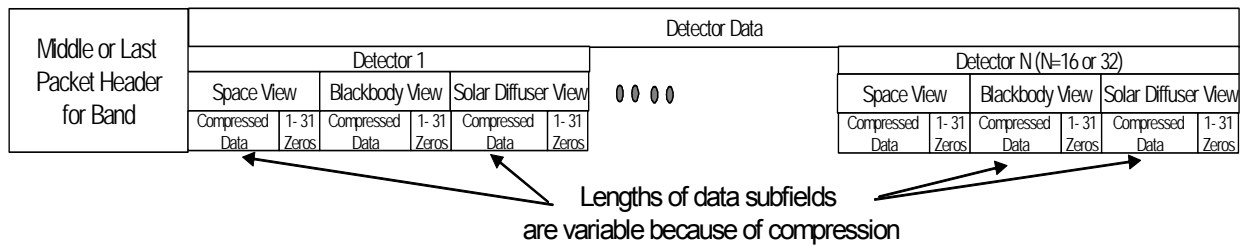

Figure 4.1.3-3, VIIRS Format of Detector Field in Calibration Packet – Operational Mode

When the instrument is in Diagnostic mode, no compression is performed on the data. The length of each data word is 15 bits. The total length of the subfield containing the data from a view, in bits, is equal to 15 times the number of samples in the view. All data is packed.

The order of data is the same for Diagnostic mode as Operational Mode. Zeros are appended to the end of the data in each view to make the length of the view, in bits, a multiple of 32. The appended zeros should be removed as part of the depacketization process. The high level structure of the detector data field in the calibration packet for Diagnostic mode is shown in Figure 4.1.3-4, VIIRS Format of Detector Data Field in Calibration Packet – Diagnostic Mode.

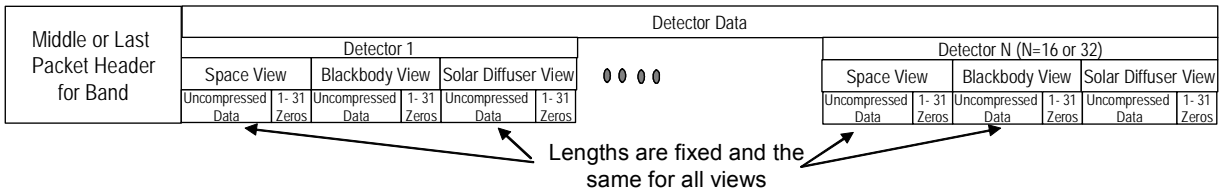

Figure 4.1.3-4, VIIRS Format of Detector Data Field in Calibration Packet – Diagnostic Mode

Top level activity diagrams for processing the Calibration Packets for Operational and Diagnostic Modes are shown in Figure 4.1.3-5, VIIRS Calibration Data Packet Processing – Operational Mode, and Figure 4.1.3-6, VIIRS Calibration Data Packet Processing – Diagnostic Mode.

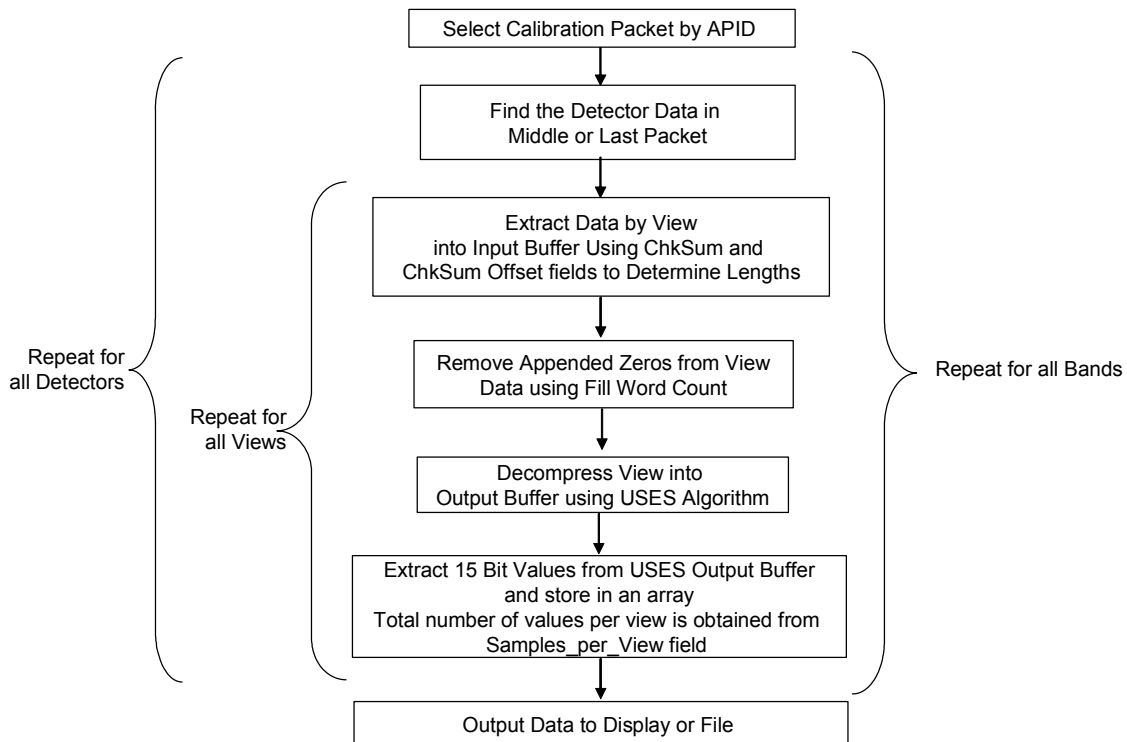

Figure 4.1.3-5, VIIRS Calibration Data Packet Processing – Operational Mode

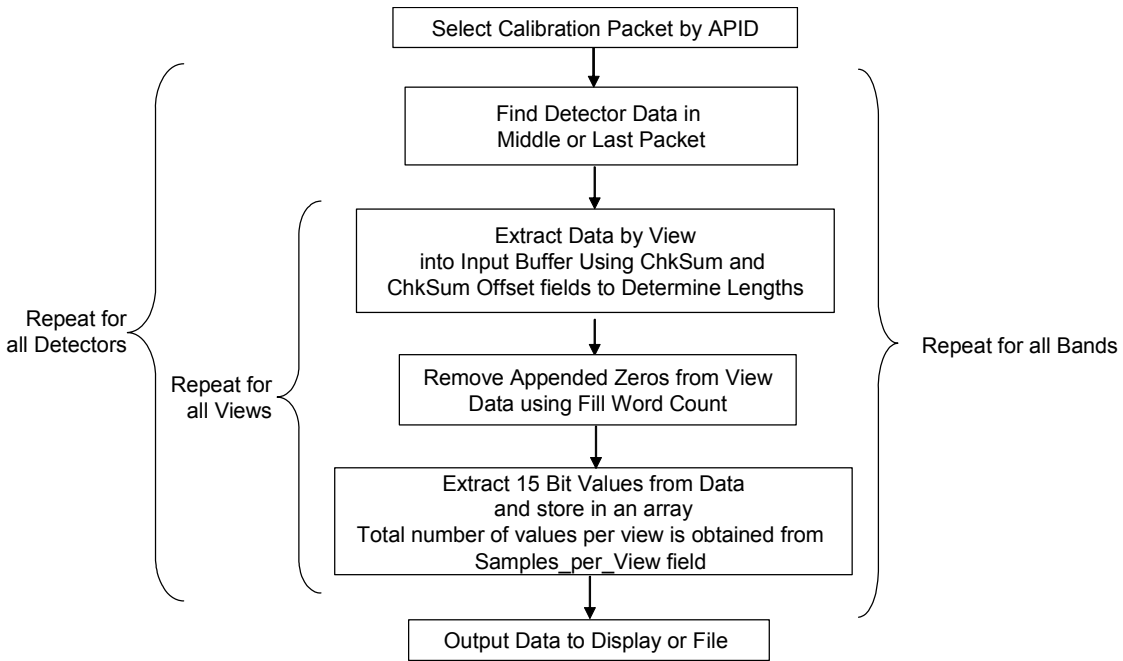

Figure 4.1.3-6, VIIRS Calibration Data Packet Processing – Diagnostic Mode

Table 4.1.3-1, VIIRS Gain, Detector, & Bit Summary for Calibration Data

[1] Band	Band Content/Mode				[2] No. Zero Bits	[3] No. Gain Bits	[4] No. Bits for Data Number	[5] Total Number of Bits	[6] No. Gain Settings	[7] No. Dets/ Band	[8] No. Bits/ Word	[9] No. Samples/ View
	Day	Night [9]	Night Sub	Diagnostic								
M1	x	x	x	x	0	1	14	15	2	16	15	48
M2	x	x	x	x	0	1	14	15	2	16	15	48
M3	x	x	x	x	0	1	14	15	2	16	15	48
M4	x			x	0	1	14	15	2	16	15	48
M5	x			x	0	1	14	15	2	16	15	48
M6	x	x	x	x	1	0	14	15	1	16	14	48
M7	x	x	x	x	0	1	14	15	2	16	15	48
M8	x	x	x	x	1	0	14	15	1	16	14	48
M9	x	x	x	x	1	0	14	15	1	16	14	48
M10	x	x	x	x	1	0	14	15	1	16	14	48
M11	x	x	x	x	1	0	14	15	1	16	14	48
M12	x	x	x	x	1	0	14	15	1	16	14	48
M13	x	x	x	x	0	1	14	15	2	16	15	48
M14	x	x	x	x	1	0	14	15	1	16	14	48
M15	x	x	x	x	1	0	14	15	1	16	14	48
M16A	x	x	x	x	1	0	14	15	1	16	14	48
M16B	x	x	x	x	1	0	14	15	1	16	14	48
I1	x	x	x	x	1	0	14	15	1	32	14	96
I2	x	x	x	x	1	0	14	15	1	32	14	96
I3	x	x	x	x	1	0	14	15	1	32	14	96
I4	x	x	x	x	1	0	14	15	1	32	14	96
I5	x	x	x	x	1	0	14	15	1	32	14	96
DNB All 4 gain stages transmitted in single band packet	x	x	x	x	1	0	14	15	NA	16	15	64 or 16 (agg. Modes 34/35)
DNB MGS All Data is med rad/med		x	x	x	1	0	14	15	NA	16	15	64
DNB LGS All data is high rad/low gain		x	x	x	1	0	14	15	NA	16	15	64

Notes:

[8] Column 8 indicates meaningful band bits before compression & after ground data recovery. For the dual gain bands (**bold** in the table), the following logic applies to the gain bit. If the gain bit = 0, this is a HIGH State. If the gain bit = 1, this is a LOW State. All DNB bands above Stage 1 are the most significant bit of the 14 bit value.

[9] The number of samples per view for the DNB band is 64 except for Aggregation Modes 34 and 35 when it is 16. The DNB aggregation mode in the cal view changes every 2 scans, cycling over agg. modes 1 to 36 in 72 scans.

4.1.4 Engineering

Data Mnemonic	VI_NU-L00000-003
APID	826 HRD – Engineering 856 HRD – Diagnostic Engineering
Description	The HRD – Engineering application packet contains the engineering data necessary to process the HRD – Science data. This includes VIIRS instrument configuration information and instrument status information (e.g., temperatures and voltages). The HRD – Diagnostic Engineering application packet contains the same data as the HRD – Engineering application packet, but is produced in Diagnostic Mode.
Packet Size	The total size of the Engineering application packets is 9319 octets.
Availability	The HRD – Engineering application packet, APID 826, is produced when the VIIRS instrument is in Operational Day and Operational Night Modes. These packets, contained with RDRs, are available in the Long Term Archive (LTA), from IDPS within 72 hours of production, and through the HRD field terminals. The HRD – Diagnostic Engineering application packet, APID 856, is produced when the VIIRS instrument is in Diagnostic Mode. These packets, contained with RDRs, are available in the LTA, from IDPS within 72 hours of production.
Frequency	When enabled, the HRD – Engineering, HRD – Diagnostic Engineering, and LRD – Engineering packets are created and transmitted once for every 1.7864 second scan.
Data Content and Data Format	The two packets have the same format. The Engineering Data contains the 64 bit timestamp from the end of the completed scan, engineering status bits, temperature data, Analog Signal Processor (ASP) data, SDSM data, and other hardware readings.

The blackbody thermistors (mnemonics ETP_BB_1 through ETP_BB_6) have special conversion coefficients; the packet values are not converted directly to temperature.

The conversion coefficients are given in Part 5 of this document. They are used in the following equation after finding the resistance of the thermistor:

$$T = 1/[A0 + A1*\ln(Rt) + A2*\ln(Rt)^2 + A3*\ln(Rt)^3], \text{ where } Rt \text{ is in ohms and } T \text{ is in Kelvin}$$

The thermistor resistance is found using the following:

$$1 / R_{Th} = I_o / (V_{off} - (DN / G_{ADC})) - (1 / R_P),$$

where R_{Th} = Thermistor Resistance (Ω),

$I_o = 0.0013795$ A, DN = Digital Number (binary value of the data),

$G_{ADC} = (16384 \text{ DN} / 5 \text{ V})$, $V_{off} = 4.145$ V, $R_P = 5000 \Omega$

4.1.5 Low Rate Data (LRD) - Science

Data Mnemonic VI_NU-L00000-004

APID	APID	Band	Wavelength (μm)	Night	Size(octets)
	1508	M04	0.555	No	1,317,248
	1509	M05	0.672	No	1,317,248
	1510	M03	0.488	No	1,317,248
	1511	M02	0.445	No	1,317,248
	1512	M01	0.412	No	1,317,248
	1513	M06	0.746	No	619,840
	1514	M07	0.865	Yes	1,317,248
	1515	M09	1.378	No	619,840
	1516	M10	1.610	Yes	619,840
	1517	M08	1.240	Yes	619,840
	1518	M11	2.250	No	619,840
	1519	M13	4.050	Yes	2,628,480
	1520	M12	3.700	Yes	1,234,240
	1521	I04	3.740	Yes	1,099,456
	1522	M16	12.013	Yes	1,234,240
	1523	M15	10.763	Yes	1,234,240
	1524	M14	8.550	Yes	1,234,240
	1525	I05	11.450	Yes	1,099,456
	1526	I01	0.640	No	1,645,600
	1527	I02	0.865	No	1,645,600
	1528	I03	1.610	No	1,099,456
	1529	DNB	0.700	Yes	439,072

Description	The LRD-Science application packets contain the same information as the HRD-Science application packets described in Section 4.1.2. In fact they are created from the HRD Science data; however the LRD-Science packets are processed differently, as explained in Section 4.1.5.1 below, and are JPEG2000 compressed by the spacecraft before being sent to the ground. The LRD-Science packets are broadcast to the LRD field terminals via the NPOESS spacecraft L-Band antenna. See Section 4.1.2, HRD-Science, for further description regarding the VIIRS science data packets.
Packet Size	See the APID field of this table (above).
Availability	The LRD science application packets, APID 1508 through 1529, are produced when the VIIRS instrument is in Operational Day Mode. However, only the science application packets, APID 1514 (M7), 1515 (M10), 1517 (M8), 1518 (M13), 1520 (M12), 1521 (I4), 1522 (M16), 1523 (M15), 1524 (M14), 1525 (I5), and 1529 (DNB) are produced when the VIIRS instrument is in Operational Night Mode. The LRD science application packets are only available through the LRD field terminals.
Frequency	When enabled, the LRD – Science packets are created and transmitted once for every 1.7864 second scan. However, only a subset of VIIRS LRD bands will be transmitted at any time.
Data Content and Data Format	See Section 4.1.2, HRD-Science, for Data Content and Data Format for the VIIRS science data packets. See the following subsection for the special on board processing of these packets in the VAP.

4.1.5.1 VAP Processing of LRD Packets

The VIIRS Auxiliary Processor (VAP) is a function of the PSP-SBC that generates HRD (High Rate Data) and LRD (Low Rate Data) by processing the input VIIRS science data packets produced in operational mode. It then forwards the HRD and LRD packets to the Data Server Unit (DSU) for further processing and storage. The HRD data has been discussed in Section 4.1.2; it is discussed here only to explain the differences from the LRD.

The VAP receives the (HRD) mission data from the VIIRS instrument. This data has already been aggregated, differentially encoded and Rice compressed (lossless). Bow-tie deletion has not been performed, as this processing is disabled on the VIIRS

instrument for NPOESS. Bow-tie deletion, differentially encoding and Rice compression are desired for HRD data but not for the LRD data. Therefore the same mission data is routed to two paths by the VAP. For the HRD downlink data the VAP performs the bow-tie deletion, repacketizes the data, and forwards the packets to DSU. For the LRD downlink data the VAP performs Rice Decompression, Differential Decoding, repacketizes the data, and forwards the packets to the DSU. An overview of the processing is given in Figure 4.1.5.1-1, VAPS Processing Overview.

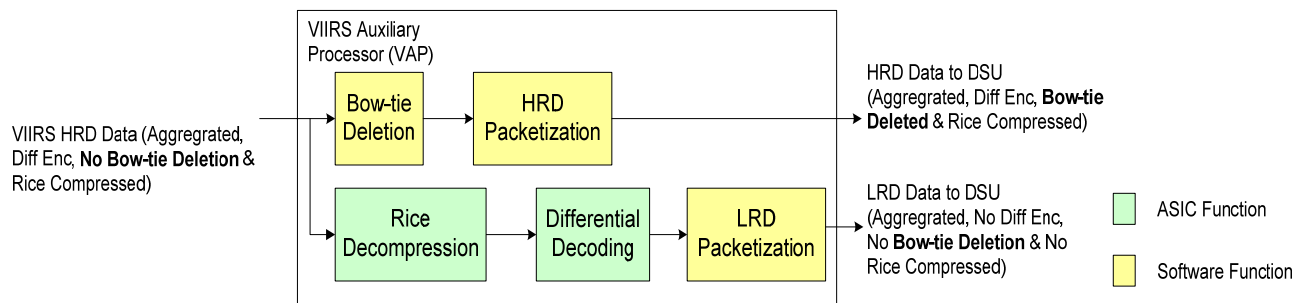

Figure 4.1.5.1-1, VAPS Processing Overview

To generate LRD data the VAP will pass the VIIRS science data through the PSP's Rice Decompressor Decoder ASIC (RDD) hardware module to generate raw uncompressed differentially decoded pixel data. FSW will then form JPEG2000 tiles from this processed pixel data, form CCSDS tile packets and forward the packets on to the DSU.

The VAP carries out Rice decompression and differential decoding on the VIIRS data using the PSP/RDD. The aggregation zone data is extracted from the VIIRS data packets, sent to the RDD for processing, and the resulting data collected in tile format, as shown in Figure 4.1.5.1-2, Data Flow Description between SBC/RDD.

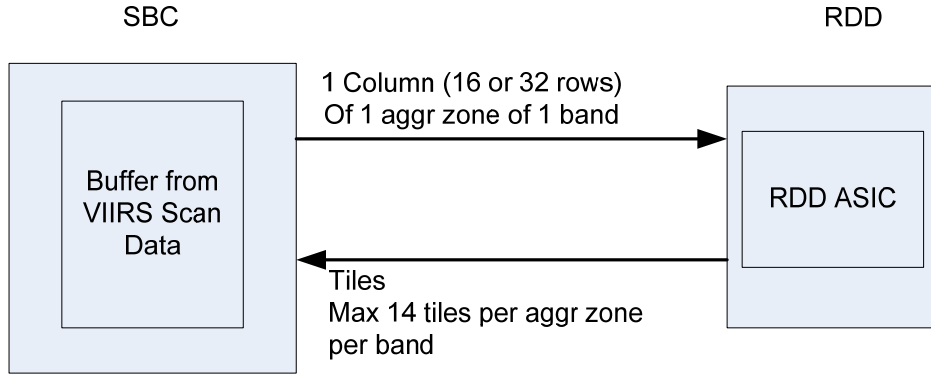

Figure 4.1.5.1-2, Data flow description between SBC/RDD.

The VAP sends the VIIRS data to the RDD module one column of an aggregation zone of one band (16 or 32 rows) at a time for each of the 22 bands of one scan. Aggregation zones from each band are processed in a particular order. The data transfer structure is further described in Figure 4.1.5.2-3, Data Transfer Structure from SBC to RDD Module and Table 4.1.5.2-1, Data Transfer Structure from SBC to RDD Module.

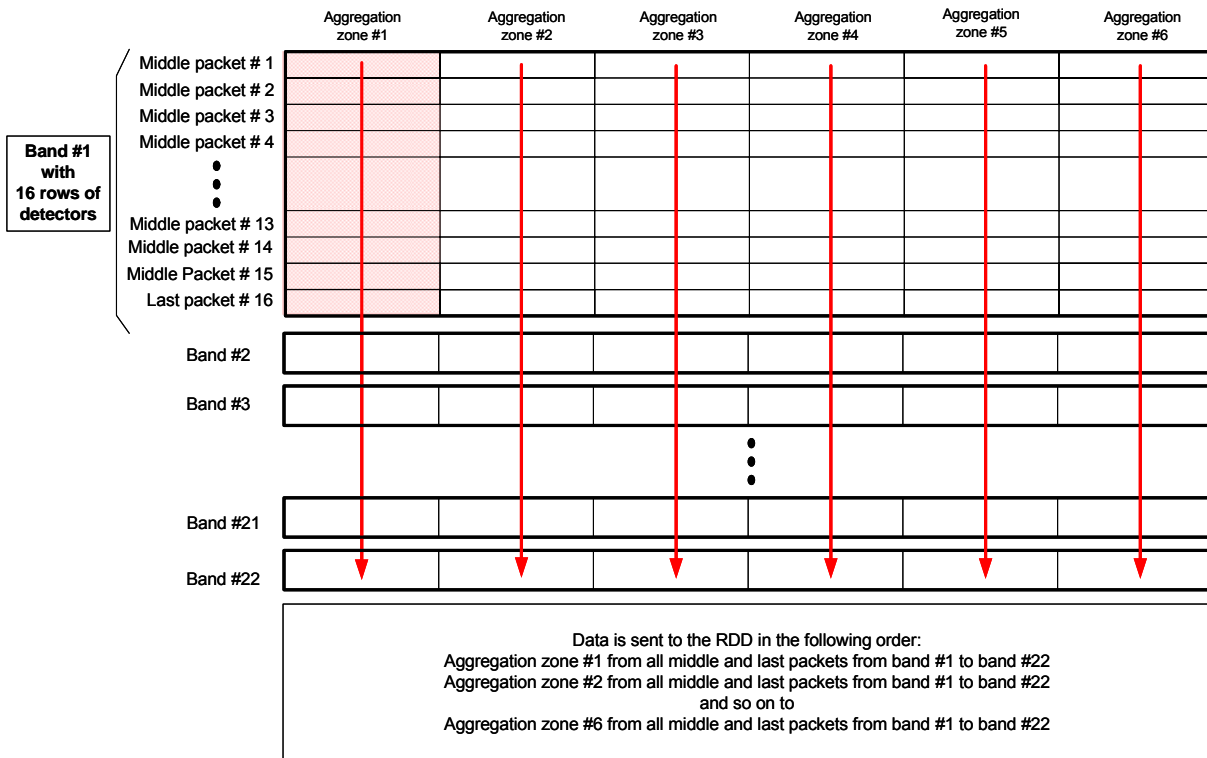

Figure 4.1.5.1-2, Data Flow Description between SBC/RDD

Under software control, an aggregation zone is written to an input buffer where it is decompressed. The RDD Decodes the bit stream, bit-wise since the compressed bit stream is not byte aligned.

Here the decompressed data it is available for output back to software or for use in a differential decoding operation with aggregation zone data from another band which has been previously loaded into one of the input buffers. 11 bands need to be decoded. Decoding is performed sample by sample (15 bits). FSW controls the sequence of data flows and decompression / differential decoding operations performed so as to regenerate raw uncompressed and decoded VIIRS science data. The VAP LRD generator shall execute the RDD sequence once for each aggregation zone (from zone #1 to #6) to complete the RDD processing of the entire scan worth of VIIRS science data.

Table 4.1.5.1-1, Data Transfer Structure from SBC to RDD Module

		Number of Tiles Return From RDD For Each Aggregation Zone Data.						
		(Note; Partial tiles are saved and combined with the next aggregation zone data to form a complete tile except for aggregation zone #6.)						
Tile dim. (pixel) / Band Type	Bits per pixel	Aggr Zone 1	Aggr Zone 2	Aggr Zone 3	Aggr Zone 4	Aggr Zone 5	Aggr Zone 6	Total Number of Tiles per Band
16 X 128 pixel SGMR	12	5 tiles	2 tile	5 tile	5 tile	2 tile	6 tile	25 tiles
32 X 128 pixel IMG	12	10 tiles	5 tile	10 tile	9 tile	6 tile	10 tiles	50 tiles
16 X 128 pixel DGMR	13	5 tiles	5 tile	14 tile	14 tile	6 tile	5.25 tile	49.25 tiles
16 X 128 pixel DNB	15	6 tile	3 tile	6 tile	6 tile	4 tile	6.75 tiles	31.75 tiles

Decompressed and differentially decoded aggregation zone data for each band is sent back from the RDD and written to specific addresses in the SBC memory. After all data for all bands of one image (one, two or four scans) is written back, the VAP FSW will group those tiles according to the current image format. The number and size of the tiles for each band is presented in Table 4.1.5.1-2, Tile Format for LRD Packets.

Table 4.1.5.1-2, Tile Format for LRD Packets.

Image Size: Single Scan					
Tile Size in pixel and band type	# of bands	Bits per pixel	# of tiles per band	Tile grouping- Each tile group will be sent in one middle or last packet.	# of CCSDS packets in the packet set
16 X 128 SGMR	9	12	25	3 groups of 8 tiles 1 groups of 1 tile	5
32 X 128 IMG	5	12	50	12 groups of 4 tiles 1 group of 2 tiles	14
16 X 128 DGMR	7	13	49.25	6 groups of 8 tiles 1 group of 1.25 tiles	8
16 X 128 DNB	1	15	31.75	3 groups of 8 tiles 1 group of 7.75 tiles	5
Image Size: Dual Scan					
Tile Size in pixel and band type	# of bands	Bits per pixel	# of tiles per band	Tile grouping- Each tile group will be sent in one middle or last packet.	# of CCSDS packets in the packet set
32 X 128 SGMR	9	12	25	6 groups of 4 tiles 1 groups of 1 tile	8
64 X 128 IMG	5	12	50	25 groups of 2 tiles	26
32 X 128 DGMR	7	13	49.25	12 groups of 4 tiles 1 group of 1.25 tiles	14
32 X 128 DNB	1	15	31.75	7 groups of 4 tiles 1 group of 3.75 tiles	9
Image Size: Quad Scan					
Tile Size in pixel and band type	# of bands	Bits per pixel	# of tiles per band	Tile grouping- Each tile group will be sent in one middle or last packet.	# of CCSDS packets in the packet set
64 X 128 SGMR	9	12	25	12 groups of 2 tiles 1 groups of 1 tile	14
128 X 128 IMG	5	12	50	50 groups of 1 tiles	51
64 X 128 DGMR	7	13	49.25	24 groups of 2 tiles 1 group of 1.25 tiles	26
64 X 128 DNB	1	15	31.75	15 groups of 2 tiles 1 group of 1.75 tiles	17

For each complete image (one, two, or four scans), the VAP will form CCSDS packet sets for each band and send them to the DSU. The headers are populated with the LRD APIDs and correct length information, and the RDD processed tile group data written to the data fields. If a default pattern is being sent as a result of day-night mode transition the 8 bits of the tenth (spare) byte of the secondary header in the LRD segmented

packet are sets as follows:

- Bit #1 = 0 Default pattern transmitted for scan #1
- Bit #1 = 1 No default pattern transmitted for scan #1
- Bit #2 = 0 Default pattern transmitted for scan #2
- Bit #2 = 1 No Default pattern transmitted for scan #2
- Bit #3 = 0 Default pattern transmitted for scan #3
- Bit #3 = 1 No Default pattern transmitted for scan #3
- Bit #4 = 0 Default pattern transmitted for scan #4
- Bit #4 = 1 No Default pattern transmitted for scan #4
- Bit#5-8 = 0000

One segmented CCSDS packet is sent for each band data of an image by creating the first packet, the middle packets, and the last packet of the new packet set. The first packet will contain the metadata for the current band; for dual and single-scan images the unused meta-data field of the first packet will contain don't-care pattern (0x00 hex). The format is shown in Figure 4.1.5.1-3, First Packet Format of the LRD Segmented Packet.

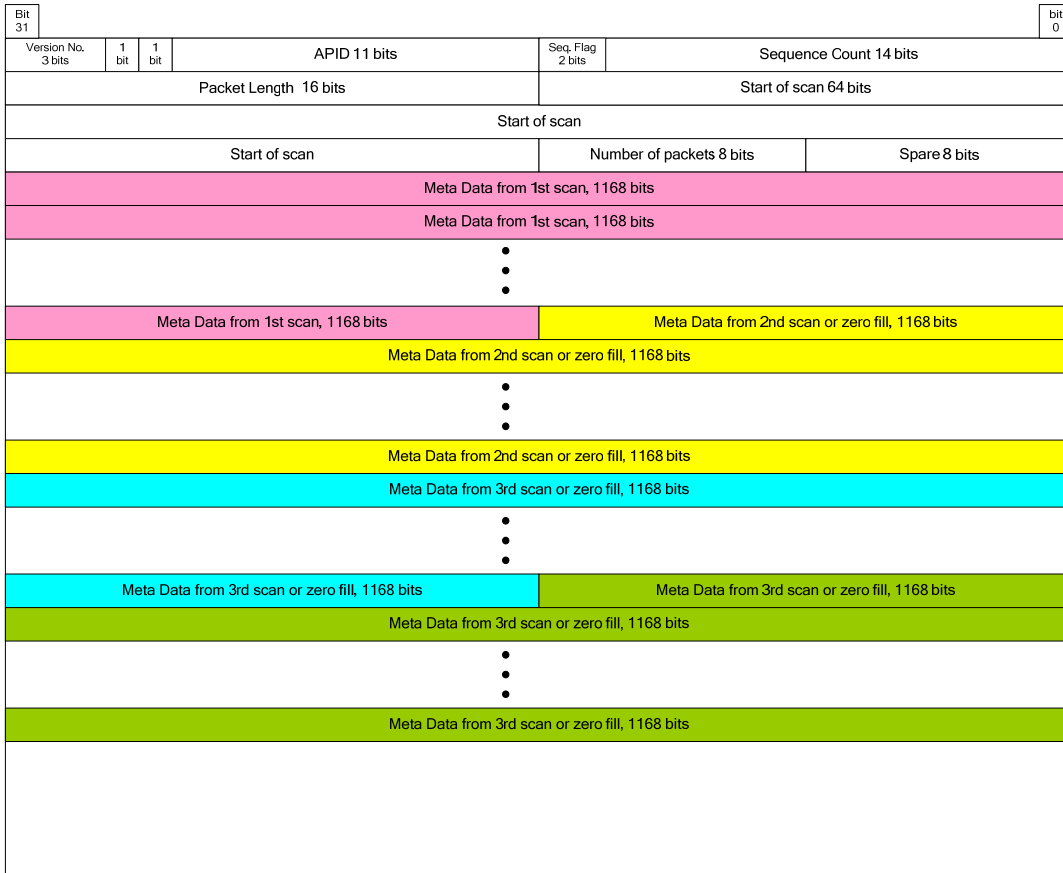

Figure 4.1.5.1-3, First Packet Format of the LRD Segmented Packet

The middle and last packets will be populated with pixel data. The format is shown for 12 bit pixel data in Figure 4.1.5.1-4, Middle/ Last Packets Format of LRD Segmented Packet with 12-bit Pixels.

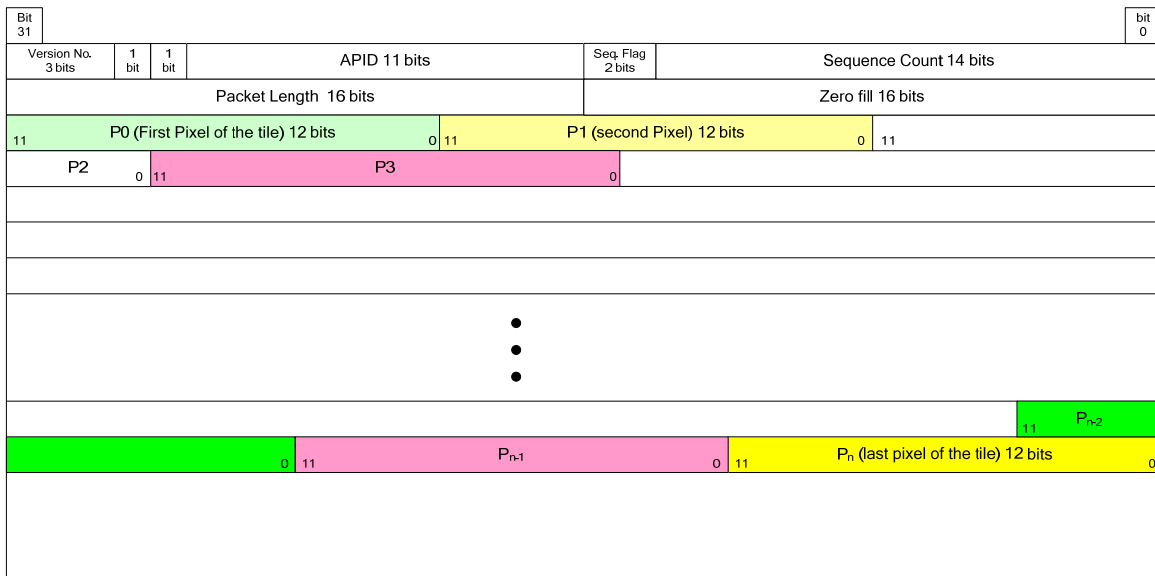

Figure 4.1.5.1-4, Middle/ Last Packets Format of LRD Segmented Packet with 12-bit Pixels

After packetization the PSP sends the 22 LRD segmented sets to the DSU for compression and downlink routing. The VIIRS LRD APs are compressed in order to meet LRD downlink bandwidth constraints. A JPEG2000 algorithm is implemented by the JPEG2000 Compression ASIC (JCA) in the DSU, allowing a configurable compression capability for LRD link. The DSU processes each data packet as it arrives into SBC memory. Each packet in a packet set contains a tile or a tile group. The first packet of each segmented set contains Meta Data for that band; this is not compressed, but is passed through the JCA to Data Formatter ASIC (DFA). The rest of the packets in the segmented set are processed by the JCA. The appropriate JCA configuration for each packet is maintained by the DSU FSW and supplied to the JCA by the DSU FSW prior to receiving the packets. The JCA performs lossy JPEG2000 compression on the tiles, at programmable compression ratios from 2 to 17, as defined in the VIIRS Compression Table. Each tile in a tile group is compressed individually, but the final JPEG2000 bit stream contains all the tiles in a tile group. The JCA updates the packet length in the primary header. The compressed LRD CCSDS packets, with headers containing APIDs designating them as the final compressed LRD packets, are

transmitted through dedicated data lines to the DFA, which routes the packets to the LRD down link.

4.1.6 HRD – Diagnostic Calibration

Data Mnemonic	VI_NU-L00000-005
APID	855 High Rate Data – Diagnostic Calibration
Description	<p>This data structure is to the same as the HRD – Calibration packet. It is a CCSDS segmented packet containing all the Calibration data for all bands. The first segmented packet contains metadata. The 21 Middle packets and the one Last packet each contain the calibration data for one of the 22 bands. These packets contain data from either 16 or 32 detectors per band, with data from all three calibration sources (space view, solar diffuser view, and blackbody view). The calibration packet is the same whether VIIRS is in the day or night portion of its orbit</p> <p>The HRD – Diagnostic Calibration packet is produced to support diagnostic efforts. It is not compressed</p>
Packet Size	The HRD – Diagnostic Calibration application packets are segmented. The packet size for all 23 segmented packets is 129,133 octets.
Availability	The HRD – Diagnostic Calibration application packet is produced when the VIIRS instrument is in Diagnostic Mode, whether the satellite is in the day or night portion of the orbit. These packets, contained within RDRs, are available through LTA, IDPS within 72 hours, or through a HRD field terminal.
Frequency	The HRD – Diagnostic Calibration packet is created and transmitted once every 1.7864 second scan. It contains 23 segmented packets, with calibration data for all 22 bands, as explained in the Description field above.
Data Content and Data Format	The calibration data consists of 15 bit samples, with a leading (MSB) zero bit followed by 14 bits of data. The data is ordered by detector; for each detector the view order is Space, Blackbody, and Solar Diffuser. For processing details see Section 4.1.3.

4.1.7 High Rate Data (HRD) - Diagnostic

Data Mnemonic	VI_NU-L00000-006
APID	830 - 853 HRD – Diagnostic
Description	<p>The HRD – Diagnostic application packets contain the radiometric data in the visible and infrared frequencies similar to the Science application packets, however, the data differs in the following major ways:</p> <p>No aggregation is performed on the imaging and single gain band data. To highlight this fact, the contents of the Diagnostic mode science packets are called Samples (As opposed to Pixels in Operational Mode).</p> <p>Band subtraction, compression, and bow tie deletion are not performed.</p> <p>All 22 bands are packetized at all times- there is no distinction between day and night.</p> <p>The extent of a scan is limited to +/- 13.16 degrees about Nadir. This lowers the overall output data rate, which in the absence of compression and aggregation, would otherwise be larger than in Operational mode and larger than is acceptable at the system level.</p> <p>There is only one “aggregation sector” per packet. This sector contains all the data collected in the +/- 13.16 degrees scan by one detector.</p>
Packet Size	The HRD – Diagnostic application packets are segmented. The first segmented packet, including the primary and secondary headers, is 90 octets. The number of segmented packets following the first segment is equal to the number of detectors for that band (either 16 or 32).
Availability	The HRD – Diagnostic application packets, APID 830 - 853, are produced when the VIIRS instrument is in Diagnostic Mode. All packets are produced continuously, regardless if the VIIRS instrument is in the day or night portion of the orbit.
Frequency	These twenty-four packets are created and transmitted once for every 1.7864 second scan.

Data Content and Data Format

Similarly to other packets, these contain a first segmented packet with metadata, followed by 21 middle packets and one last packet. Middle and last packets contain a primary header and an Application Data field with only 1 data subfield, due to the reduced scan. Application Data consists of uncompressed 15 bit samples, with 1-32 zero bits appended to make the total length a multiple of 32 bits. The number of fill bits is indicated in the “Number of Fill Bits” subfield; these must be removed to calculate the data.

Figure 4.1.7-1, VIIRS Overview of Science Data Processing in Diagnostic Mode, summarizes the processing of data in Diagnostic Mode. Table 4.1.7-1, VIIRS Arithmetic Processing Summary, shows the processing functions implemented inside the “Arithmetic Processing” box in the figure.

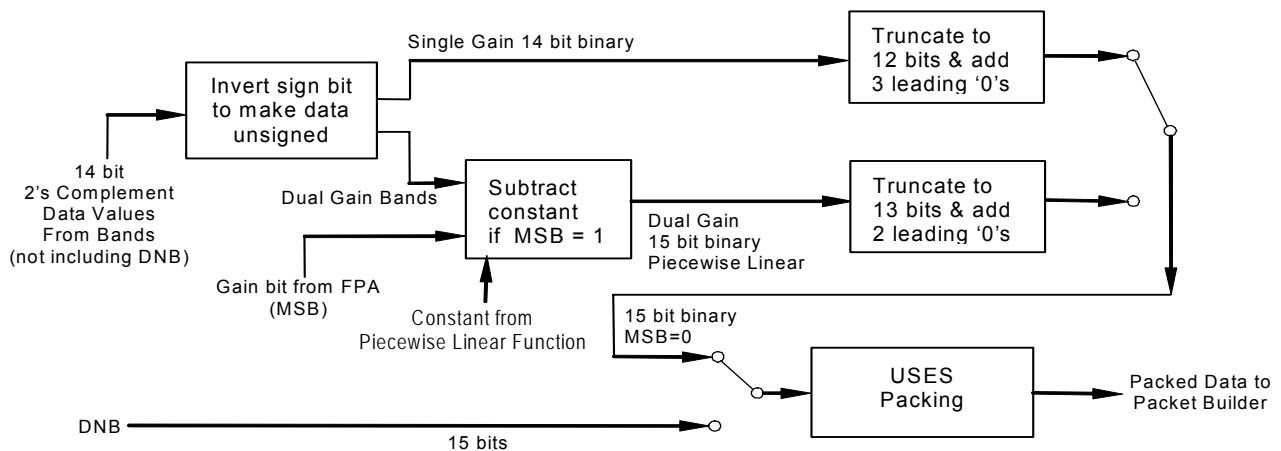

Figure 4.1.7-1, VIIRS Overview of Science Data Processing in Diagnostic Mode

Table 4.1.7-1, VIIRS Arithmetic Processing Summary

Band(s)	A (14 bits)	B (14 bits)	C (15 bits)
M16	M16 #1	M16 #2	$C = (A + B) / 2 + (MSB=zero)$
Dual gain (No Pred)	2^{13}	Data + 2^{13}	$C = B - A + (MSB= zero)$
Single gain (No Pred)	2^{13} (14 bits)	Data + 2^{13}	$C = B - A (MSB= zero)$

Although no aggregation is performed in Diagnostic Mode, samples corresponding to one scan from one detector are treated as one “aggregation zone” for the purposes of packetization. Because bow tie deletion is not performed the number of samples from

each detector in a band is the same. The number of samples per scan in Diagnostic Mode is less than in Operational Mode because the scan is limited to +/- 13.16 degrees. The overall process of data collection in Diagnostic Mode is shown in Figure 4.1.7-2, VIIRS Overview of Data Handling in Diagnostic Mode, below.

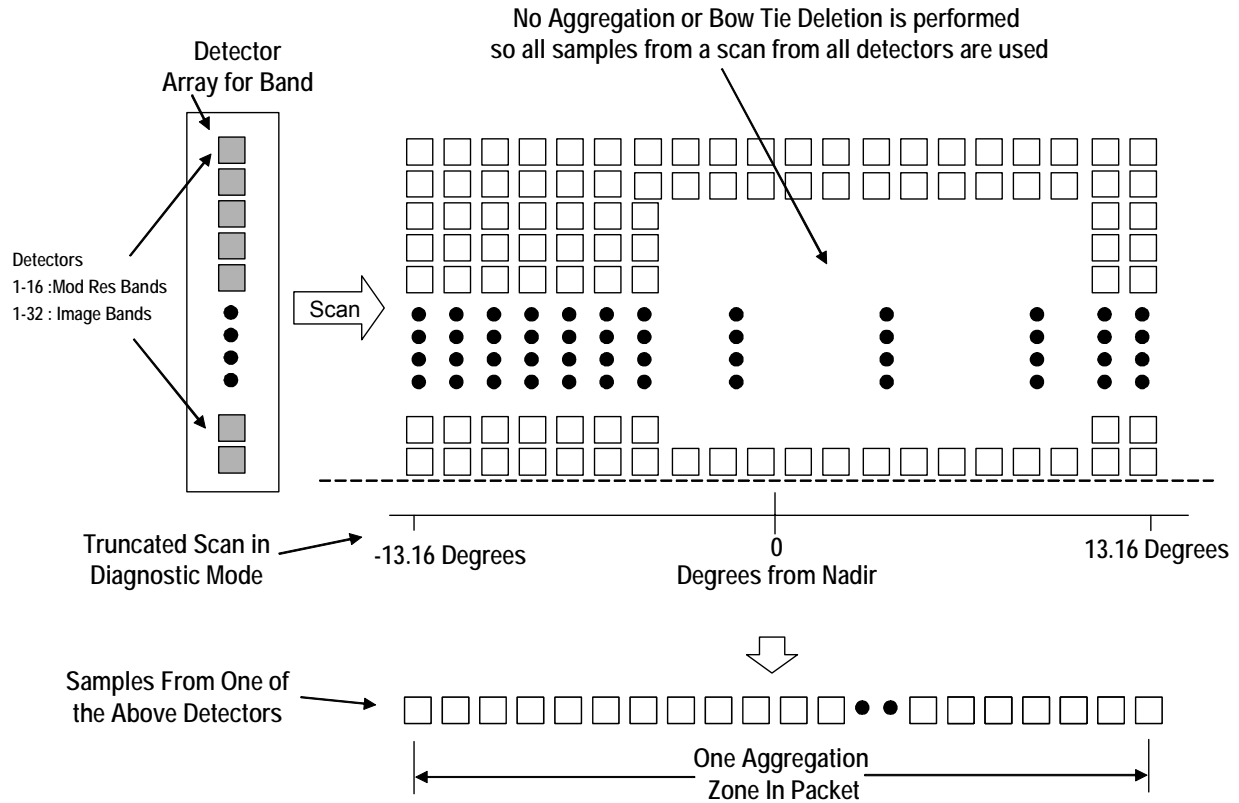

Figure 4.1.7-2, VIIRS Overview of Data Handling in Diagnostic Mode

Table 4.1.7-2, VIIRS Summary of Number of Samples in Aggregation Zone by Band Type, shows the number of samples in the “aggregation zone” by band type. All samples are 15 bits and are packed prior to be inserted into the packet.

Table 4.1.7-2, VIIRS Summary of Number of Samples in Aggregation Zone by Band Type

Detectors	Number of Samples in "Aggregation Zone" *	Total Samples
1 through 16	Moderate Resolution Bands (16 Bands) 1480	1480
1 through 32	Imaging Bands (5 Bands) 2960	2960
1 through 16	DNB (1 Band) 1376	1376
* The use of the term "aggregation zone" is for consistency with previous section and with the nomenclature used to describe packet fields. No aggregation is actually performed.		

4.1.7.1 Diagnostic Mode Arithmetic Processing

The arithmetic processing shown in Figure 4.1.7-2, VIIRS Overview of Data Handling in Diagnostic Mode, is simpler than in Operational Mode because no band differencing or prediction is performed. This is reflected in the left hand side of the figure by the addition of a constant 2^{13} , as opposed to the differencing operation shown earlier in for operational mode. The details of the processing in Diagnostic Mode are otherwise the same as described earlier in Operational Mode Arithmetic Operations and are not be repeated here.

4.1.7.2 Diagnostic Mode Packet Processing

Figure 4.1.7.2-1, VIIRS Science Data Processing Overview – Diagnostic Mode, shows the processing of the science data packets in Diagnostic Mode

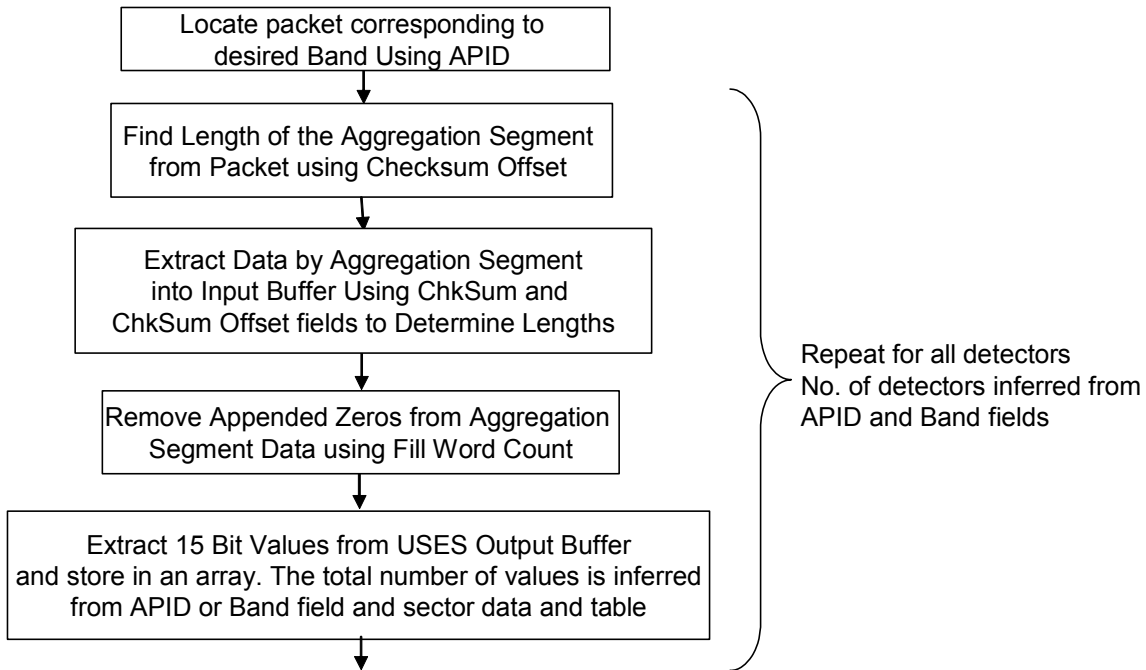

Figure 4.1.7.2-1, VIIRS Science Data Processing Overview – Diagnostic Mode

4.1.7.3 Diagnostic Mode Day/Night Band Processing

The format of the DNB HRD packet when the instrument is in diagnostic mode is also very similar to the other bands. There is only one “aggregation zone” and the data is not compressed. In Diagnostic mode, the length of a scan is shortened to ensure that the instrument data rate is within specification. As a result, the number of samples in a scan of the DNB is 1376. The format of the DNB data is shown schematically in Figure 4.1.7.3-1, VIIRS Format of DNB Data when in Diagnostic Mode.

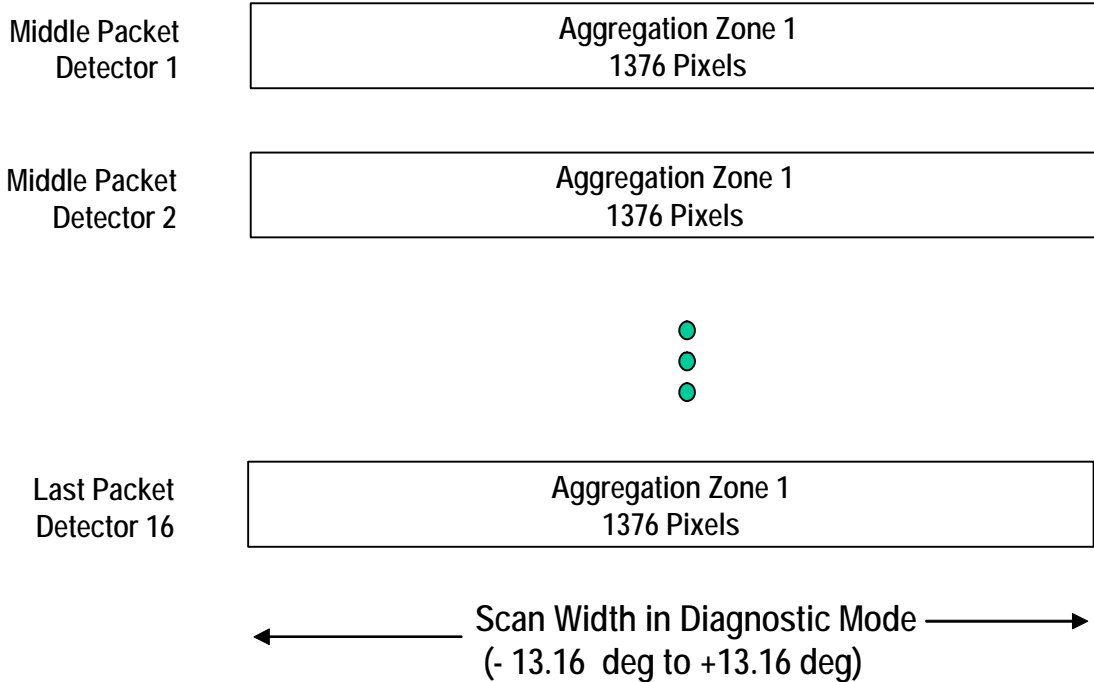

Figure 4.1.7.3-1, VIIRS Format of DNB Data when in Diagnostic Mode

When in diagnostic mode, the DNB only operates in Aggregation Mode 32), as shown in Table 4.1.7.3-1, VIIRS DNB Reference Information. This does not affect the process for extracting data from a packet however.

Table 4.1.7.3-1, VIIRS DNB Reference Information

Sector in CCSDS Packet	Aggregation Mode	Scan Angle relative to Nadir (degrees)	Samples per Detector per scan	<i>Sector in CCSDS Packet</i>	<i>Aggregation Mode</i>	<i>Scan Angle relative to Nadir (degrees)</i>	<i>Pixels per Detector per scan</i>
1	32	-55.4	80	4	1	0.0	184
1	31	-55.3	16	4	2	9.4	72
1	30	-54.7	64	4	3	13.0	88
1	29	-54.0	64	4	4	17.2	72
1	28	-53.3	64	4	5	20.5	80
1	27	-53.0	32	4	6	23.9	72
1	26	-52.7	24	4	7	26.8	64
1	25	-51.8	72	4	8	29.2	64
1	24	-51.3	40	4	9	31.5	64
1	23	-50.5	56	Total Samples in Sector 4			760
1	22	-49.9	40	5	10	33.6	64
1	21	-49.1	48	5	11	35.6	64

Sector in CCSDS Packet	Aggregation Mode	Scan Angle relative to Nadir (degrees)	Samples per Detector per scan	<i>Sector in CCSDS Packet</i>	Aggregation Mode	Scan Angle relative to Nadir (degrees)	Pixels per Detector per scan
1	20	-48.6	32	5	12	37.4	80
1	19	-47.8	48	5	13	39.6	56
1	18	-47.2	32	5	14	41.0	80
1	17	-45.9	72	5	15	42.9	72
Total Samples in Sector 1			784	5	16	44.5	72
2	16	-44.5	72	Total Samples in Sector 5			488
2	15	-42.9	72	6	17	45.9	72
2	14	-41.0	80	6	18	47.2	32
2	13	-39.6	56	6	19	47.8	48
2	12	-37.4	80	6	20	48.6	32
2	11	-35.6	64	6	21	49.1	48
2	10	-33.6	64	6	22	49.9	40
Total Samples in Sector 2			488	6	23	50.5	56
3	9	-31.5	64	6	24	51.3	40
3	8	-29.2	64	6	25	51.8	72
3	7	-26.8	64	6	26	52.7	24
3	6	-23.9	72	6	27	53.0	32
3	5	-20.5	80	6	28	53.3	64
3	4	-17.2	72	6	29	54.0	64
3	3	-13.0	88	6	30	54.7	64
3	2	-9.4	72	6	31	55.3	16
3	1	0.0	184	6	32	55.4	80
Total Samples in Sector 3			760	Total Samples in Sector 6			784

Figure 4.1.7.3-2, VIIRS DNB Processing Flow – Diagnostic Mode, shows at a top level the processing for DNB data when the instrument is in Diagnostic Mode. Note that although the above discussion treats the number of samples per scan in Diagnostic Mode as a constant, the number of samples is stored in the packet. Thus, if a command changes the scan length, the correct number of samples can be determined from this variable.

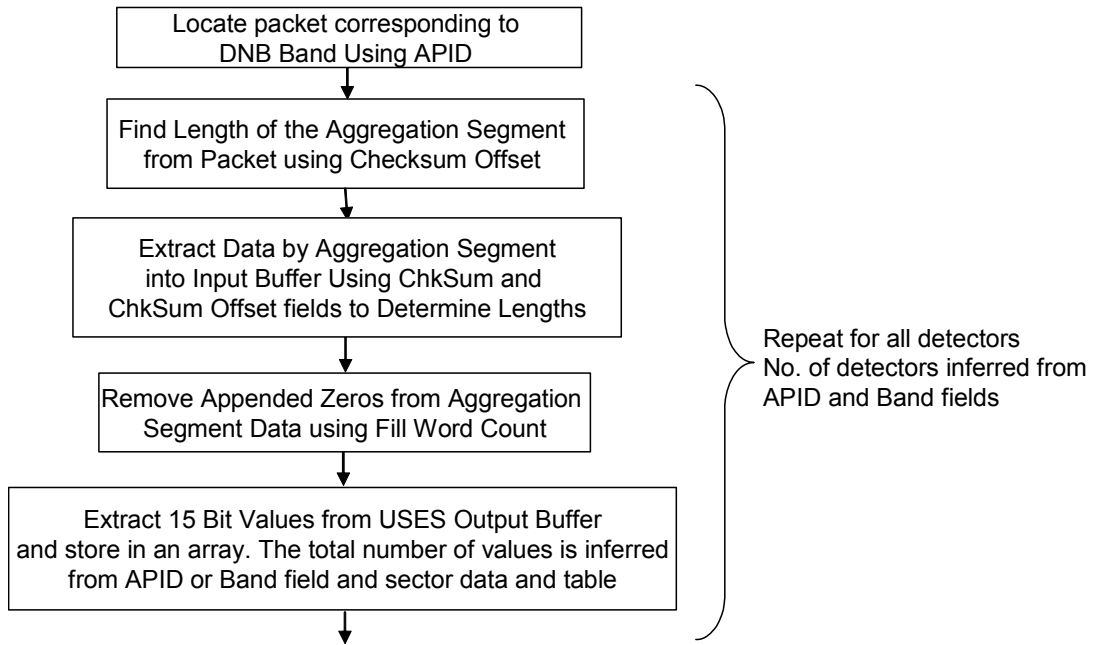

Figure 4.1.7.3-2, VIIRS DNB Processing Flow – Diagnostic Mode

4.1.8 Health and Status and Diagnostic Dwell Telemetry

Data Mnemonic	VI_NU-L00000-007
APID	768 Health and Status 773 Diagnostic Dwell Telemetry
Description	<p>The Diagnostic Dwell Telemetry application packet (APID 773) has the same data format as the Health and Status application packet (APID 768). Health and Status application packets are produced when the VIIRS instrument is in Operational Mode.</p> <p>High rate dwell telemetry can be commanded when the VIIRS instrument is in Diagnostic Mode. Diagnostic Dwell Telemetry application packets are produced in place of the Health and Status application packets.</p>
Packet Size	The Health and Status Diagnostic application packet and Dwell Telemetry application packet size is 446 octets, including all headers.
Availability	Health and Status application packets are produced when the VIIRS instrument is in Operational Mode or Diagnostic Mode. The Diagnostic Dwell Telemetry application packet can be commanded only when the VIIRS instrument is in the Diagnostic Mode. Only one or the other is available at any given time.
Frequency	When enabled the Health and Status application packet or the Diagnostic Dwell Telemetry application packet is created and transmitted once for every 1.7864 second scan.
Data Content and Data Format	This standalone packet contains an Application Data field containing a VIIRS Sequence Count (4 octets), Packet Time (8 octets), Format Version and Instrument Number (1 octet each), spare bits (2 octets), FSW Version (2 octets), 8 Reserved octets, followed by 404 octets of telemetry values. See Part 5 of this document for details.

4.1.9 Memory Dump

Data Mnemonic	VI_NU-L00000-008
APID	780 Memory Dump
Description	The VIIRS Memory Dump application packet contains the memory contents within the VIIRS instrument. Memory resides on the 64MB Dynamic RAM, the Command and Telemetry Assembly (CTA) RAM and Register, the Digital Preprocessor (DPP), and the A and B side of the 1394 Registers. Memory includes both flight software and tables used to operate the instrument and control the processing of data within the instrument.
Packet Size	Memory Dump packets are variable in size, depending on the memory addresses requested. A single packet cannot exceed 65,506 octets, including headers. When the length exceeds this single packet limit the memory dump data is contained in a packet sequence. The maximum number of packet segments in a sequence is 256. The largest memory area possible to dump, 4 MB, requires a group of 65 packets.
Availability	The Memory Dump application packet is available when commanded. The VIIRS instrument must be in Diagnostic Mode to request Memory Dump packets.
Frequency	The Memory Dump application packet is produced when commanded.
Data Content and Data Format	Memory dumps can be standalone or packet sequences, depending on the size of the dump. For both, the secondary header timestamp indicates the time the memory was read. The Application Data field contains a Format Header (16 octets), Memory Dump Header (10 octets), Memory Dump Data, and User Check Sum (2 octets). The Memory Dump Header fields give the memory address (4 octets), remaining number of octets in the dump (4 octets), type of dump (1 octet indicating RAM, EEPROM or table), and ends with 8 spare bits. The User Check Sum is the 16 bit arithmetic check sum (modulo 65536) of the octets in the Application Data field. The dump packet structure is shown below in Table 5.2.4-1, VIIRS Memory Dump User Data Field Contents.

Table 5.2.4-1, VIIRS Memory Dump User Data Field Contents

Field	Sub-Field	Length	Description
Format Header	Sequence Count	32 bits	Running total count of all types of packets sent by VIIRS since power on

Field	Sub-Field	Length	Description
			or 32-bit rollover
	Packet Time	64 bits	CCSDS Time format for time the memory was read
	Format Version	8 bits	Format Version is 0x01
	Instrument Number	8 bits	Instrument Number is 2
	Spare	16 bits	0x 0000 – unused
Memory Dump Header	MEM Address - MSW Memory Address Most Significant Word	16 bits	For RAM dump: Memory target address MSW For Table dump: Offset in words into table identified by Table ID For each packet this gives the starting address/offset of the data in the <i>current</i> packet.
	MEM Address - LSW Memory Address Least Significant Word	16 bits	For RAM dump: Memory target address LSW For Table dump: Offset in words into table identified by Table ID For each packet this gives the starting address/offset of the data in the <i>current</i> packet
	MEM Data Size - MSW Memory Data Size Most Significant Word	16 bits	The remaining number of octets to be dumped MSW Must be an even number of octets, and does not include the checksum
	MEM Data Size - LSW Memory Data Size Least Significant Word	16 bits	The remaining number of octets to be dumped LSW Must be an even number of octets, and does not include the checksum
	MEM Select	8 bits	0x 00 – RAM dump 0x 01 – EEPROM dump 0x 02 – Table dump Others - Reserved
	Spare	8 bits	0x 00 unused
	Memory Dump Data	MEM Data	Variable
User Check Sum	Checksum	16 bits	Arithmetic Checksum of octets in the User Data Field (modulo 65536.)

4.2 Advanced Technology Microwave Sounder

The Advanced Technology Microwave Sounder (ATMS) is a 22-channel millimeter wave radiometer that measures radiances in six frequency bands centered at: 23 GHz, 31 GHz, 50-58 GHz, 89 GHz, 166 GHz, and 183 GHz. The ATMS is a total-power radiometer, with “through-the-antenna” radiometric calibration. A pair of antenna apertures, scanned by rotating flat-plate reflectors, collects radiometric data. Scanning is performed cross-track to the satellite motion from sun to anti-sun, using the “integrate-while scan” type data collection.

The primary roles of the ATMS are to obtain data during overcast conditions, to provide corrections for cloud effects in partly cloudy conditions, and to provide a “first-guess” for iterative physical retrievals. Processed mission data from the ATMS and the CrIS produce three of the NPP/NPOESS EDRs:

- Atmospheric Temperature Profiles
- Atmospheric Moisture Profiles
- Atmospheric Pressure Profiles

These radiance values, along with calibration, housekeeping, diagnostic and other data are packaged into the AP types shown below in Table 4.2.1-1, ATMS Application Packet Types. The formats for each of these AP types are described in the following subparagraphs.

The ATMS physical configuration consists of two major modular assemblies: an upper assembly and a lower assembly. The upper assembly includes the antenna, scan drive, and receiver components, mounted on a precision optical bench. The lower assembly contains the power supplies, scan drive electronics, and the signal processing electronics. It also provides the base plate for the spacecraft mechanical and thermal interface. The lower and upper assemblies are bolted and pinned together; pinning of the assemblies allows disassembly and reassembly without disturbing initial alignment. The lower assembly electronics boxes mount to the base plate, which provides the mechanical/thermal interface to the spacecraft

The block diagram in Figure 4.2-1, ATMS Block Diagram, shows the functional

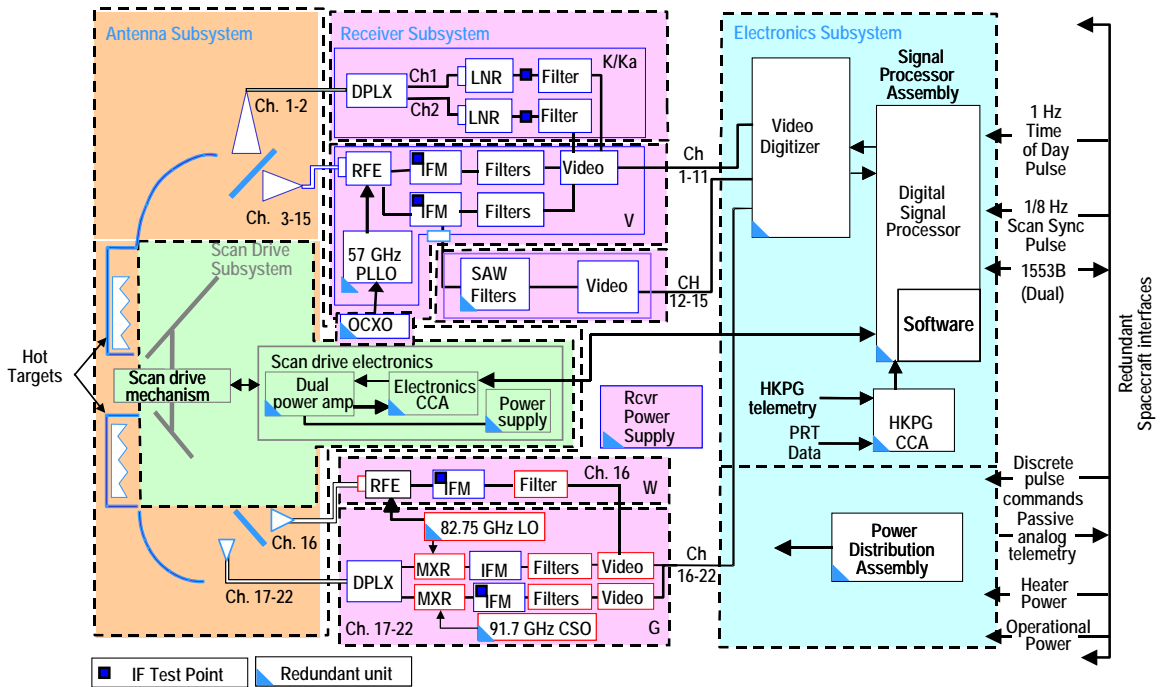

Figure 4.2-1, ATMS Block Diagram

decomposition into subassemblies and the signal flow interfaces. The antenna subsystem provides the RF signals to the receiver, for both earth-viewing scene data and hot and cold calibration samples. The antenna subsystem includes the parabolic reflecting elements and feedhorns, which establish the antenna beam characteristics, and polarizing grids and diplexers, which multiplex the signals into six bands. The hot calibration targets --one for K, Ka and V-bands (KAV_WL) and one for W and G-band (WG_WL) -- and associated temperature sensors are also part of the antenna subsystem. The antenna pattern when viewing cold space establishes the cold calibration performance.

The scan drive subsystem includes the Scan Drive Mechanism (SDM) and the Scan Drive Electronics (SDE). Telemetry from the SDM reports on the main motor, the compensation motor and resolver. The flat reflectors attached to the SDM have shrouds to ensure a stable thermal load for the hot calibration targets. The SDE

performs the servo control functions according to a stored scan angle profile, which can be updated during the mission. The SDE receives scan pattern uploads and scan synchronization pulses from the Signal Processing Assembly (SPA), and provides boundary pulses at the beginning of each scan position to control data sampling and integration. It also provides angle position data for the center of each scan position.

The receiver subsystem amplifies and down-converts the radiometric RF signals from the antenna, and performs filtering and square-law detection of all 22 channels. The receiver subsystem is divided into four shelves: K/Ka-band, V-band, W-band and G-band – plus its own power supply. The shelf components are receiver front ends (RFE), local oscillators – an oven controlled crystal oscillator (OCXO), a cavity stabilized oscillator (CSO), a phase lock-loop oscillator (PLO or PLL) and a Gunn Diode oscillator (GDO) – intermediate frequency (IF) modules, filters and square-law detectors in the video output units.

The video outputs of all channels are sent to the SPA in the electronics subsystem. The Video Digitizer (VD) performs analog multiplexing and digitization of the radiometric video signals. The housekeeping Circuit Card Assembly collects and digitizes housekeeping data from all of the ATMS subsystems. In conjunction with hosted flight software, the Digital Signal Processor (DSP) performs digital integration of the VD outputs over the sampling period, creates science and housekeeping data packets for communication to the spacecraft over the 1553B interface, processes commands received over this interface, and controls instrument operation.

The Power Distribution Assembly performs EMI filtering and transient suppression for the 28 V operational power. All electrical interfaces with the spacecraft (power, 1553B Command and Telemetry (C&T), pulse commands, and analog telemetry) are through the electronics subsystem.

The thermal control subsystem provides passive thermal control of the instrument with Multi-layered Insulation (MLI) blankets on exterior surfaces and efficient conductive coupling to the spacecraft cold plate. It also provides dual-redundant thermostatically-controlled survival heaters.

The design incorporates redundancy for all components of the electronics subsystem, the scan drive electronics, and the receiver power supply and local oscillators. Figure 4.2-2, ATMS Redundancies, illustrates these redundancies and the associated cross strapping between redundant components. Table 4.2-1, ATMS Redundancy Configurations, lists the eight possible redundancy configurations.

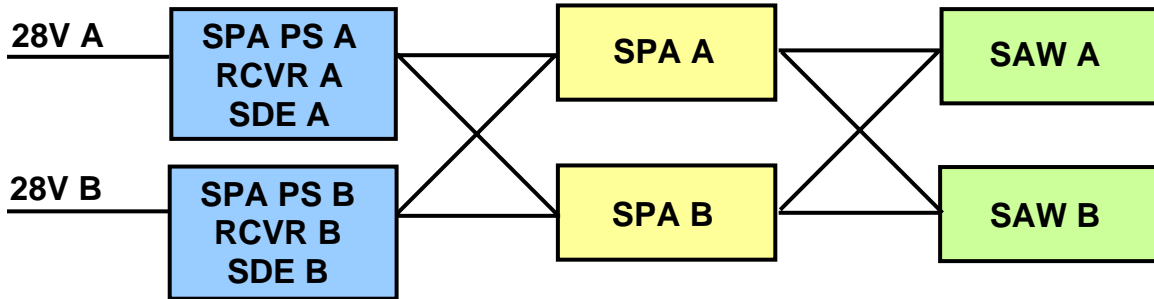

Figure 4.2-1 ATMS Redundancies

Table 4.2-1, ATMS Redundancy Configurations

CONFIG.	SPA PS	RECEIVER SELECT	SDE SELECT	SPA CROSS	SAW CROSS
1	A	REC A - PLO, CSO, GDO, RPS	SDE A	SPA A	SAW A
2					SAW B
3				SPA B	SAW B
4					SAW A
5	B	REC B - PLO, CSO, GDO, RPS	SDE B	SPA B	SAW B
6					SAW A
7				SPA A	SAW A
8					SAW B

Note: the antenna, Receiver, and SDM do not have redundancy so are not included in this table

The ATMS scanning geometry and corresponding angular velocity profile are illustrated in Figure 4.2.1-3, ATMS Operational Scan Pattern. Every 8/3 second scan period is divided into 148 equal epochs of approximately 18 msec. During Operational mode, the radiometric signals are sampled for 96 Earth scene epochs, 4 cold calibration epochs and 4 hot calibration target epochs as shown in the figure. During Diagnostic mode, the scan profile can be commanded to change and the radiometric signals can be sampled

at all 148 epochs.

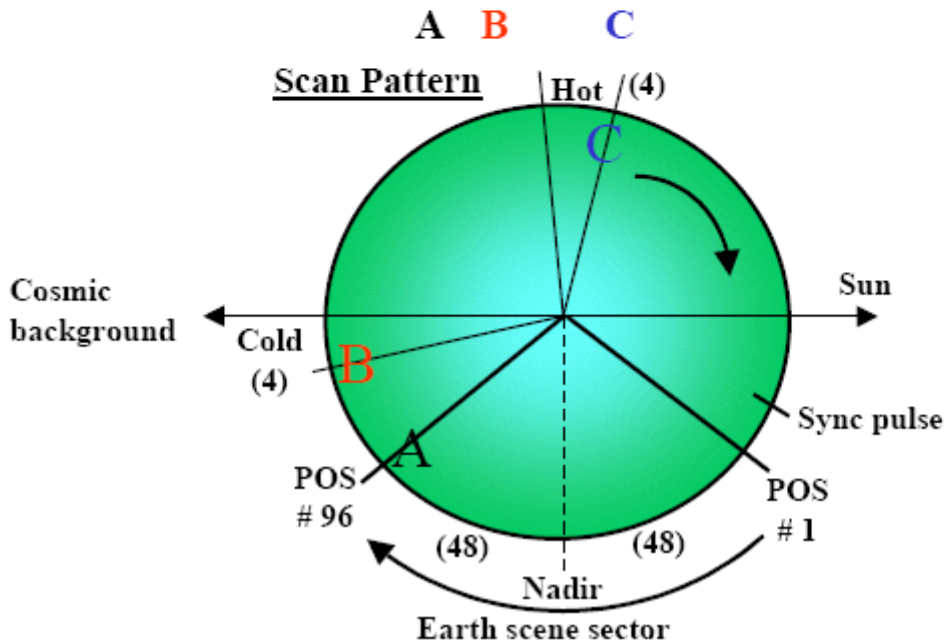
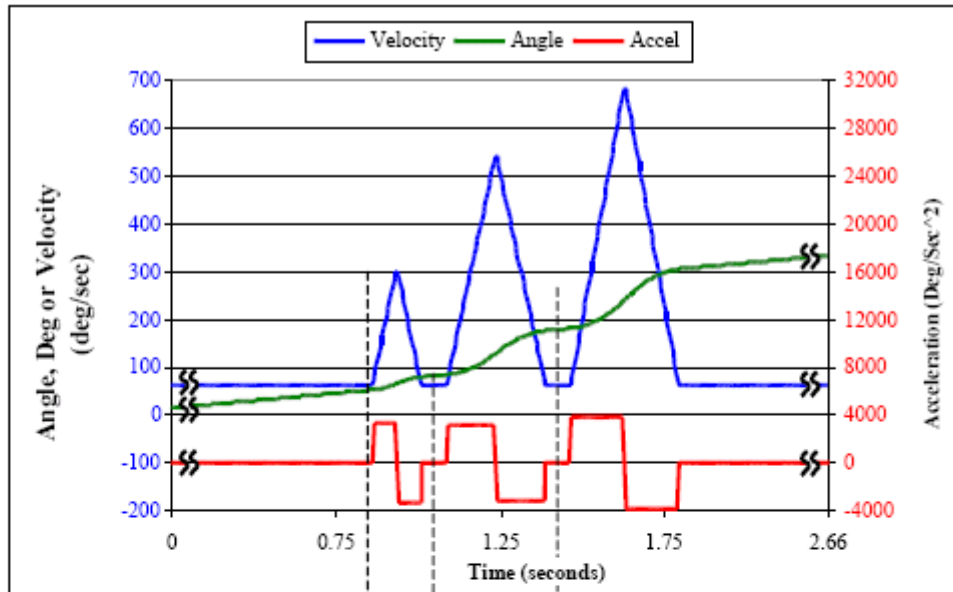

Figure 4.2-3, ATMS Operational Scan Pattern

4.2.1 ATMS Data Collection Modes and Packet Processing

The ATMS instrument modes that are relevant to AP production include:

- Operational Mode
- Diagnostic Mode (and submodes)

4.2.1.1 Operational Mode

In operational mode, the ATMS executes the operational scan profile, which views 96 earth scenes, 4 adjustable cold space scenes, and 4 internal warm calibration target scenes. This mode produces science, calibration, engineering, and housekeeping APs. Operational mode also executes continuous built-in tests (CBITs) to monitor instrument performance. The science data produced in operational mode consists of pixel brightness temperature values. Calibration and engineering APs produced during each scan period support SDR generation. Housekeeping APs include instrument health and status indications and related measurements.

4.2.1.2 Diagnostic Mode

Diagnostic “mode” is not established by a unique “mode” command. The ATMS enters Diagnostic mode when commanded to Continuous Sampling, Dwell or Point and Stare, or to output the Diagnostic or Memory Dump Packets. The ATMS continues to output Science, Calibration and Engineering packets. If commanded to Continuous Sampling or Point and Stare, the Science data is output in APID 536 instead of APID 528.

ATMS instrument diagnostic mode operation includes initiated built-In test (IBIT) checks that determine the state of the instrument and sources of error. The IBIT tests video, telemetry dwell, point and stare, and memory functions. Operational data can be generated concurrently while in any of these diagnostic sub-modes except point and stare.

4.2.1.2.1 Video Test

Video testing checks for video signal noise using a comparison of the measured or sensed video signal with a calibrated video signal. This video test results are contained in APID 516 diagnostic APs.

4.2.1.2.2 Telemetry Dwell Test

When commanded, the ATMS will sample a selected housekeeping telemetry data point (e.g. one of the housekeeping AP data field values) at 55.5 Hz, generating APID 517 dwell APs. Dwell may be used to isolate noise sources due to supply voltage EMI or

intermittencies.

4.2.1.3 Packet Processing

This section provides an overview of the ATMS packets and general processing information that is not specific to any one type of packet.

Table 4.2.1.3-1, ATMS Application Packet Types

CDFCB-X Section	Data Mnemonic	APID	Packet Type	Generation Mode	AP Size (octets)	Packet Frequency (pkts/sec)
4.2.2 Command Status	AT_NU-L00000-001	512	Command Status	All	20	Asynchronous
4.2.3 Engineering – Launch and Early Orbit	AT_NU-L00000-002	513	LEO&A	All modes except Off/Survival	154	.125
4.2.4 Calibration	AT_NU-L00000-003	515	Calibration	Operational	444	.125
4.2.5 Diagnostic	AT_NU-L00000-004	516	Diagnostic	Operational & Diagnostics	622	.125
4.2.6 Dwell	AT_NU-L00000-005	517	Dwell	Operational & Diagnostics	312	.375
4.2.7 Engineering - Housekeeping	AT_NU-L00000-006	518	Housekeeping	All modes except Off/Survival	162	.125
4.2.8 Memory Dump	AT_NU-L00000-007	524	Memory Dump	Commanded	Variable	Asynchronous
4.2.9 Science - Operational Mode	AT_NU-L00000-008	528	Science	Operational	62	39
4.2.10 Engineering – Hot Calibration Temperatures	AT_NU-L00000-009	530	Engineering – Hot Cal Temperatures	Operational	48	.375
4.2.11 Engineering – Health and Status	AT_NU-L00000-010	531	Engineering	Operational & Diagnostic	162	.125
4.2.12 Science – Diagnostic Mode	AT_NU-L00000-011	536	Science	Diagnostic	62	55.5
4.2.13 Hardware Error Status	AT_NU-L00000-012	543	Hardware Error Status	Fault Occurrence	20	Asynchronous

The ATMS telemetry transferred via the MIL-STD-1553B bus consists of data packets in the CCSDS Path Protocol Data Unit format described earlier in this document. All fields in the ATMS data packets are big endian.

For science packets, the time tag indicates the time of the boundary pulse following the included data. For all other packets the UTC time represents the time of the oldest sample of the collection. Since data values are sampled in the order they appear in the packet, Housekeeping, Dwell and the Engineering packet's UTC time refers to the time of the first data value. The UTC times are calculated from the last second's UTC time plus the time difference in microseconds between the sample's 24 bit time value and the 24 bit timestamp register value for the one second time.

The ATMS uses three types of temperature monitoring:

Temperature of the instrument mounting interface, monitored by the spacecraft, and reported in spacecraft telemetry.

Passive Analog Temperature (PAT) sensors within the instrument, powered by the spacecraft. The signals are processed by the spacecraft and reported in spacecraft telemetry. The ATMS instrument uses five redundant PAT sensors.

Platinum resistance temperature sensors (PRTs) within the instrument, processed by the instrument, and digitized for inclusion in the ATMS Housekeeping and Engineering data packets.

Unique coefficients for each PRT based on the manufacturer's data are required to determine the temperature. The signal from each PRT is digitized via an A-to-D converter aboard the ATMS instrument, providing a count from 0 to 65,535 representing the resistance of a given PRT. The count to resistance relationship is given by:

$$R = \frac{\gamma_R}{\gamma_1 - \gamma_0} [C - \gamma_0] - R_C \quad (1)$$

Where: C = number of counts measured for the PRT

R_C = resistance of cable to the PRT (applicable only to 2 wire PRTs)
and γ_R , γ_0 , and γ_1 are parameters defined in Table 4.2.1.3-2, ATMS PRT Parameters.

Table 4.2.1.3-2, ATMS PRT Parameters

Parameter	4-Wire PRTs	2-Wire PRTs
γ_R	PAM resistance (word 1 or 2 of Calibration Data Packet)	Housekeeping reference resistance = MUXREST1_A, MUXREST2_A, MUXREST1_B, MUXREST2_B (words 212 – 215 of Calibration Data Packet)
γ_0	4W_GND_A or _B (word 46 of Hkpg and Engr Data Packet)	2W_GND_A or _B (word 47 of Hkpg and Engr Data Packet)
γ_1	KV_WL_4WRES or WG_WL_4WRES (word 9 or 17 of Eng-HotCal Temperatures Data Packet)	[HK_2WREST1_A, HK_2WREST2_A] or, [HK_2WREST1_B, HK_2WREST2_B] (words 44 and 45 of HK and Engr Data Packets)

After computing the resistance, R, the Callendar-Van Dusen equation is then used to determine the physical temperature of each PRT. The equation is given below:

$$R = R_0 \left[1 + \alpha \left(T - \delta \left(\frac{T}{100} - 1 \right) \right) \left(\frac{T}{100} \right) - \beta \left(\frac{T}{100} - 1 \right) \left(\frac{T}{100} \right)^3 \right]$$

Where:

T = physical temperature of the PRT

R = resistance (ohms) of the PRT (from equation 1)

R_0 = resistance at ice point of the PRT (supplied by PRT vendor)

α, δ, β = constants measured for the PRT (supplied by PRT vendor)

The Newton-Raphson technique is used to perform the inversion, to compute T for a given R.

4-Wire PRTs

The 4-wire PRTs measure the temperature of the ATMS calibration loads. This information is needed in SDR processing, so temperature measurements are in the Engineering--Hot Cal Temps Packet. To support the processing of the 4-wire PRTs as described above, the following coefficients are provided in data words 3-62 of the Calibration Data Packet: $R_0, \alpha, \delta, \beta$.

Receiver Shelf 2-Wire PRTs

All 2-wire PRTs assess the health and status of the instrument. They are not needed in producing SDRs, so measurements are included in the Engineering—Health and Status Packet.

Processing of the receiver shelf 2-wire PRTs is identical to the 4-wire PRT processing, except that β is assumed to be 0 and is not transmitted as part of the calibration data packet for those sensors. R_0 , α , and δ are provided in words 140-155 of the Calibration Data Packet. The cable resistance, R_C , is also provided, for use in the counts-to-resistance conversion equation above.

Other 2-Wire PRTs

Other 2-wire PRTs are used purely as health and status indicators and do not require the same precision as the 4-wire and receiver shelf PRTs. These temperatures, therefore, are processed according to the following linear equation, except for the scan drive PRTs:

$$T = A_1(R - R_0) = A_1(R' - R'_0)$$

$$R' = R + R_C = \frac{\gamma_R}{\gamma_1 - \gamma_0} [C - \gamma_0]$$

$$R'_0 = R_0 + R_C$$

where

T is the temperature, in degrees C,

R'_0 and A_1 are parameters transmitted in the Calibration Data Packet, words 156-211

The parameter A_1 is related to the Calendar-Van Dusen parameters by this equation:

$$A_1 = \frac{1}{\alpha(1 + \delta/100)R_0}$$

The scan drive PRTs (words #40 and 41 of the housekeeping packet) are processed using this equation:

$$[1,000,000 * (Count - 399.3371)] / [8,905,947 - (1907.3 * Count)]$$

4.2.2 Command Status

Data Mnemonic	AT_NU-L00000-001
APID	512
Description	This AP indicates a command execution and execution status.
Packet Size	20 octets
Availability	This AP is produced once in response to each command received.
Frequency	Asynchronous
Data Content and Data Format	This AP contains 3 application data fields: <ul style="list-style-type: none">-16 bit packet ID from the associated command packet-16-bit command function code-16-bit command status code

4.2.3 Engineering – Launch, Early Orbit & Anomaly

Data Mnemonic	AT_NU-L00000-002
APID	513
Description	This AP contains temperature, voltage, and current measurements from critical components within the ATMS receiver, Signal Processor Assembly, and Scan Drive Subsystems as well as parameters that indicate the status of the instrument (e.g., component on or off, primary or redundant component enabled)
Packet Size	154 octets
Availability	These APs are produced when the instrument is on.
Frequency	.125 pkts/sec
Data Content and Data Format	These packets do not have a secondary header. The application data is 74 - 16-bit fields containing instrument status indications and health measurements

4.2.4 Calibration

Data Mnemonic	AT_NU-L00000-003
APID	515
Description	This AP contains the calibration coefficients and temperature measurements necessary to process the raw radiometric count values into calibrated brightness temperature EU values.
Packet Size	444 octets
Availability	Calibration data packets are produced when commanded.
Frequency	.125 pkts/sec
Data Content and Data Format	<p>The packet contains constants unique to each ATMS unit necessary to process the mission and housekeeping data. The parameters calibrate the receiver outputs, temperature sensors and the optical alignment of the sensor. See Section 4.2.1 for more information on PRT temperature sensors.</p> <p>The application data is 215 – 16-bit fields containing platinum resistance temperature sensor measurements, calibration target offset and alignment values, and radiometric-channel quadratic coefficient values. See Part 4 of this document for specific field content.</p>

4.2.5 Diagnostic

Data Mnemonic	AT_NU-L00000-004
APID	516
Description	This AP contains time stamps for start of scan and scan synch, as well as video signal measurements from the two hot calibration targets, KAV & WG.
Packet Size	622 octets
Availability	This AP is produced upon command.
Frequency	.125 pkts/sec
Data Content and Data Format	The application data is 304 – 16-bit fields containing test channel data consisting of 148 samples of test data from the lower band shelves (KAV) and 148 samples from the upper band shelves (WG). The samples monitor stable reference signals to help determine whether signal contamination is pre- or post-detection.

4.2.6 Dwell

Data Mnemonic	AT_NU-L00000-005
APID	517
Description	<p>The ATMS instrument reports selected housekeeping telemetry channels at the same rate as a radiometric signal channel (up to 55.5 Hz) in the dwell packet. The AP contains 148 dwell sample values. The telemetry item is commanded to be one of the following Data Word Number ranges:</p> <ul style="list-style-type: none">Words 2 to 25Words 30 to 47Words 56 to 72
Packet Size	312 octets
Availability	Dwell data packets are produced when commanded in diagnostic mode.
Frequency	.375 pkts/sec
Data Content and Data Format	<p>The application data is 149 – 16-bit fields containing:</p> <ul style="list-style-type: none">Word number from the Eng H&S application data148 16-bit dwell sample values

4.2.7 Engineering – Housekeeping

Data Mnemonic	AT_NU-L00000-006
APID	518
Description	This AP contains temperature, voltage, and current measurements from critical components within the ATMS receiver, Signal Processor Assembly, and Scan Drive Subsystems as well as parameters that indicate the status of the instrument (e.g., component on or off, primary or redundant component enabled)
Packet Size	162 octets
Availability	These APs are produced when the instrument is on.
Frequency	.125 pkts/sec
Data Content and Data Format	The application data is 74 - 16-bit fields containing instrument status indications and health measurements

4.2.8 Memory Dump

Data Mnemonic	AT_NU-L00000-007
APID	524
Description	The ATMS dumps the contents of a contiguous memory region in response to a dump command. The memory dump command can request memory from program RAM, data RAM, an I/O address, or the SDE.
Packet Size	Variable – The memory dump size is requested as a memory dump command argument. When the request is greater than 501 16-bit words, the ATMS will generate a packet sequence containing the requested memory image segment, each of which will not exceed 1024 octets in size and will always be an even number of octets.
Availability	Memory dump APs are generated upon command
Frequency	Asynchronous
Data Content and Data Format	<p>The time tag field in the memory dump packet indicates the time the dump packet was created.</p> <p>Multiple dump packets are needed in order to retrieve the sections of memory larger than 1002 octets. In this case all packets will be flagged as standalone and have secondary header timestamps with the time of packet creation. The first packet will give the 'Number of Words to Follow' for the entire dump.</p> <p>The maximum rate of memory dump packets is limited to 30 kbps, the maximum ATMS rate for mission data. Memory dump packets are sent at a rate that will not exceed the 30 kbps rate when combined with other ATMS mission data.</p> <p>The application data is formatted as follows:</p> <ol style="list-style-type: none">1. 2-bits - Memory type (0=program, 1=data RAM, 2=an I/O address, 3=scan drive electronics)2. 30-bits – Start address3. 32 bits – Integer number “N” of 16-bit memory image data words to follow4. N memory image 16-bit data words <p>To confirm a memory load, the operator can compare the Memory Dump contents to what was loaded or calculate a 16-bit checksum of the load, send a Memory Checksum Command to have ATMS return its checksum of the received load and then compare the ground calculated checksum with the one ATMS calculated. The checksum is defined as the 16-bit sum of the 16-</p>

bit words over the memory range with the overflow discarded.

4.2.9 Science – Operational Mode

Data Mnemonic	AT_NU-L00000-008
APID	528
Description	This AP contains the antenna beam scan angle and one radiometric measurement sample for all 22 microwave sensor channels.
Packet Size	62 octets
Availability	These APs are generated when the ATMS is in operational mode.
Frequency	39 pkts/sec The packet is output for 104 positions every scan (96 Earth scene positions, 4 cold calibration and 4 hot calibration positions). Since the scan duration is 8/3 seconds, the operational data rate is 19,344 bps
Data Content and Data Format	<p>The science packets contain a secondary header with a time tag indicating the time of the boundary pulse that follows the included data.</p> <p>The application data is 24 – 16-bit fields containing:</p> <ul style="list-style-type: none">-16-bits – raw antenna beam scan angle counts For the scan angle value the full 16-bit range corresponds to 360 degrees, which means the scale factor is 5.493×10^{-3} degrees per count-16-bits – error status flags-16-bit fields - 22 16 bit fields give radiometric count values for channels 1 through 22 at a single scan position

4.2.10 Engineering – Hot Calibration Temperatures

Data Mnemonic	AT_NU-L00000-009
APID	530
Description	This AP contains internal warm-calibration-target temperature measurements as measured by onboard platinum resistance temperature (PRT) sensors. These temperature measurements are used to calibrate observed earth scene radiance values. The internal known-radiance calibration sources, the KAV target and the WG target provide the known-radiance calibration sources.
Packet Size	48 octets
Availability	These APs are produced when the ATMS is in operational mode
Frequency	.375 pkts/sec
Data Content and Data Format	The application data is 17 – 16-bit fields containing: - KAV & WG calibration source PRT raw count measurements

4.2.11 Engineering – Health and Status

Data Mnemonic	AT_NU-L00000-010
APID	531
Description	This AP contains temperature, voltage, and current measurements from critical components within the ATMS receiver, Signal Processor Assembly, and Scan Drive Subsystems as well as parameters that indicate the status of the instrument (e.g., component on or off, primary or redundant component enabled)
Packet Size	162 octets
Availability	These APs are produced when the instrument is on.
Frequency	.125 pkts/sec, which is every three scans
Data Content and Data Format	<p>The UTC time in the secondary header represents the time the first sample is taken.</p> <p>The application data is 74 - 16-bit fields containing instrument status indications and health measurements. These contents are identical to the ATMS LEO&A and Housekeeping Packets: 2-wire temperature sensors, voltage monitors, scan drive telemetry and three status words</p>

4.2.12 Science – Diagnostic Mode

Data Mnemonic	AT_NU-L00000-011
APID	536
Description	This AP contains the antenna beam scan angle and one radiometric measurement sample for all 22 microwave sensor channels.
Packet Size	62 octets
Availability	When the ATMS instrument is in the point and stare diagnostic submode.
Frequency	55.5 pkts/sec In diagnostic mode, the science packet may be output 104 times every 8/3 seconds if the ATMS is in Point and Stare mode without Continuous Sampling enabled; or it may be generated approximately every 18 milliseconds if Continuous Sampling is enabled, thereby increasing the downlink rate to 27,528 bps.
Data Content and Data Format	The science packets contain a secondary header with a time tag indicating the time of the boundary pulse that follows the included data The application data is 24 – 16-bit fields containing: <ul style="list-style-type: none">-16-bits – raw antenna beam scan angle counts For the scan angle value the full 16-bit range corresponds to 360 degrees, which means the scale factor is 5.493×10^{-3} degrees per count-16-bits – error status flags-16-bit fields - 22 16 bit fields give radiometric count values for channels 1 through 22 at a single scan position

4.2.13 Hardware Error Status

Data Mnemonic	AT_NU-L00000-012
APID	543
Description	This packet type is used for instrument fault reporting
Packet Size	20 octets
Availability	This packet type is generated when the instrument encounters an anomalous condition
Frequency	Asynchronous – generated on fault occurrence
Data Content and Data Format	This packet contains 2 error status codes, each as one 16-bit data word.

4.3 Cross Track Infrared Sounder

The Cross Track Infrared Sounder (CrIS) mission is designed to collect upwelling infrared spectra at very high spectral resolution, and with excellent radiometric precision. Radiometric and other types of CrIS data are downlinked to the ground in the application packets described in Table 4.3.1-1, CrIS Application Packet Types.

The Crosstrack Infrared Sounder (CrIS), shown in Figure 4.3-1, CrIS Drawing of the Instrument, is a dynamically aligned Michelson interferometer covering 3 bands over a spectral range of $3.92 \mu\text{m}$ to $15.38 \mu\text{m}$ (650 cm^{-1} to 2550 cm^{-1}). The 8-second cross-track scan is controlled by a step-and settle-positioning system with 30 earth scene positions centered about nadir. Double-sided interferograms are collected from 9 fields of view (FOV) in a 3x3 array configuration at each position or field of regard (FOR) as shown in Figure 4.3-2, CrIS Field of Regard About Nadir and 9 Field of Views.

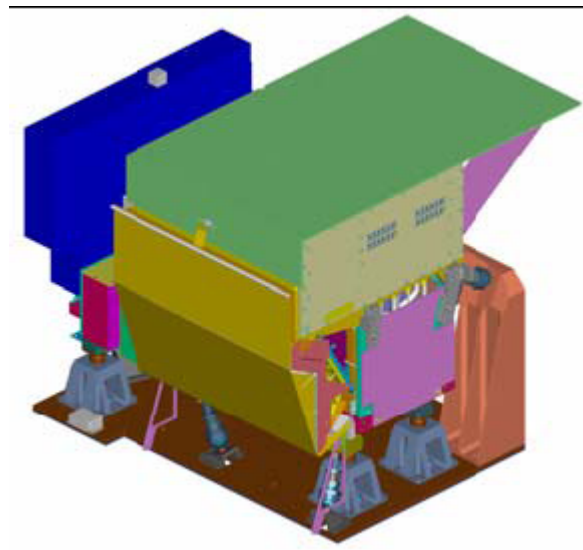

Figure 4.3-1, CrIS Drawing of the Instrument

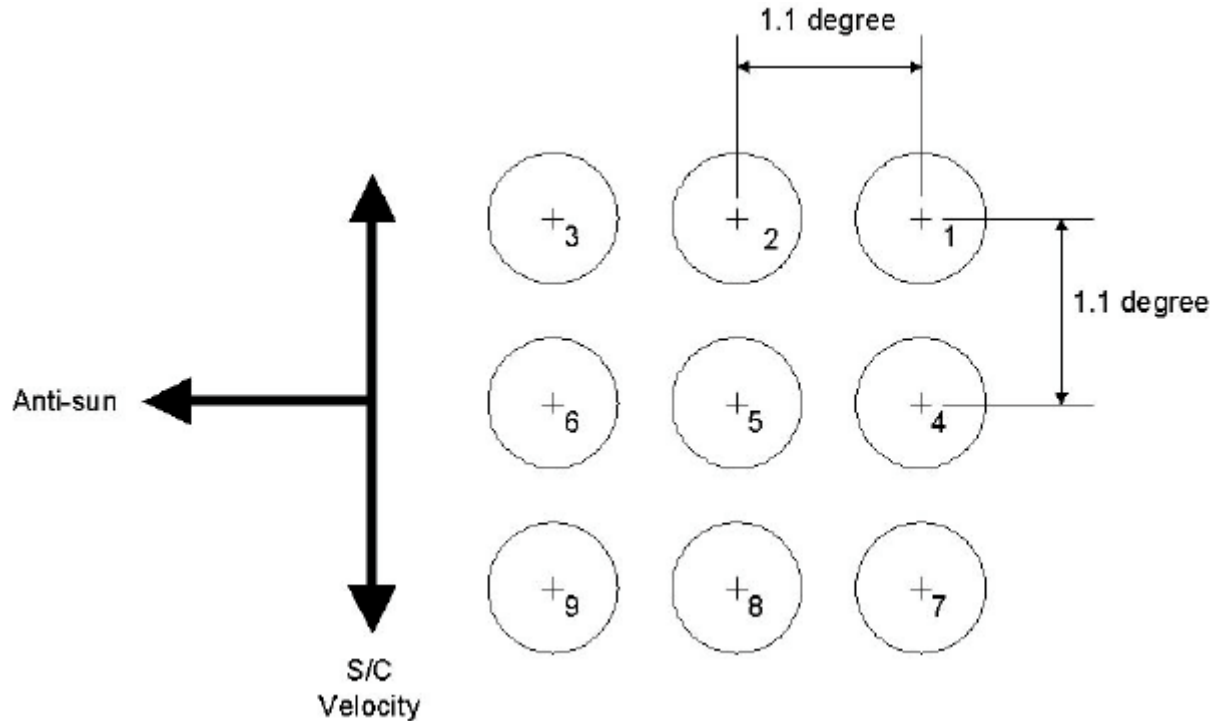

Figure 4.3-2, CrIS Field of Regard About Nadir and 9 Field of Views

The CrIS mission is to collect upwelling infrared spectra at very high spectral resolution, and with excellent radiometric precision. This data is then merged with microwave data collected by the Advanced Technology Microwave Sounder (ATMS) to construct highly accurate temperature, moisture, and pressure profiles of the atmosphere. Collectively, the CrIS and the ATMS sensors are referred to as the Crosstrack Infrared and Microwave Sounding Suite (CrIMSS).

The CrIS sensor system produces three key EDRs:

- Atmospheric Vertical Moisture Profiles
- Atmospheric Vertical Temperature Profiles
- Atmospheric Vertical Pressure Profiles

Figure 4.3-3, CrIS Signal Radiance Flow to Detectors, shows an optical path of radiation through the CrIS modules. Figure 4.3-4, CrIS Modules (Exploded View), shows an exploded view of the CrIS modules. The optical bench module provides the structural anchor for telescope, interferometer (IM), aft optics, detector cooler, and detector preamplifier modules (listed as the super module in the figure). The Scene Selection Module (SSM) contains the scan mirror, mirror baffle, bearings, cross-track and in-track scan motors and position sensors, scan electronics, earth radiators, and space radiators. The Internal Calibration Target (ICT), equipped with precision

temperature sensors, emits a radiance standard for the calibration of the CrIS data measured by the CrIS once every scan over the entire range of spectral bands. The Processing and Control Electronics (PCE) Module controls all sensor operations by processing Interferometer and SSM Commands and data, processing mission data (interferograms), collecting sensor health and status telemetry, controlling sensor temperatures, managing sensor power, and processing spacecraft commands and transmitting data.

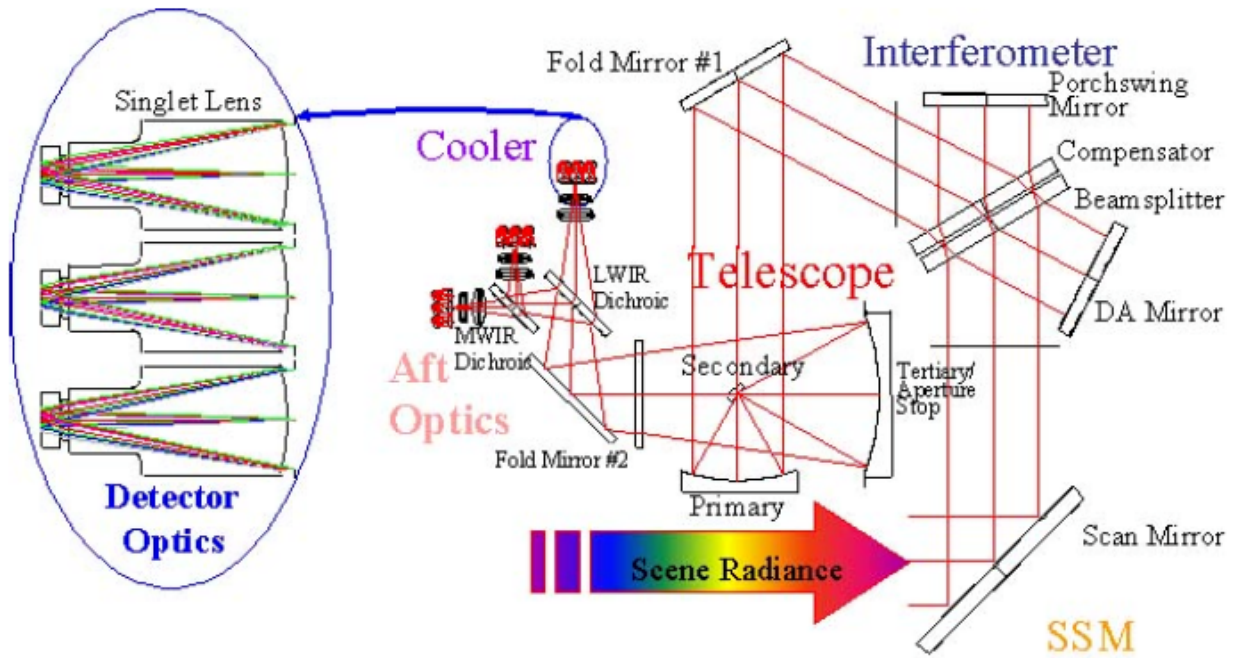

Figure 4.3-3, CrIS Signal Radiance Flow to Detectors

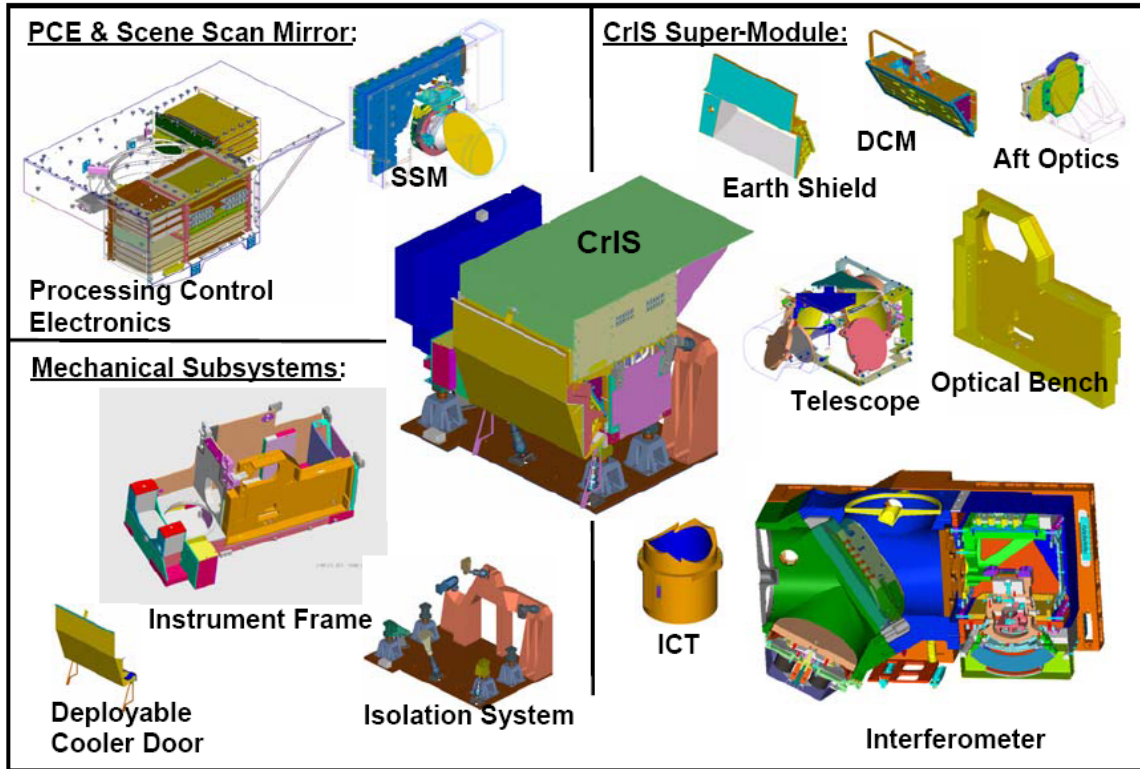

Figure 4.3-4, CrIS Modules (Exploded View)

The SSM directs Earth scene and calibration radiance into CrIS optical modules. Figure 4.3.5, CrIS Scene View: 30 Steps per 8 Second Scan, shows the scene viewed by CrIS, which consists of 30 steps of 3.33 degrees each with 0.167-second dwell time reaching full ± 48.3 -degree scene coverage. The 3 x 3 array of 14 km diameter CrIS FOV undergoes a rotation during the cross-track scan and grows to maximum of 49 x 31 km ellipses as the scan progresses away from nadir. The SSM views the scene, space and internal calibration target every 8 seconds. The scan system also includes in-track velocity compensation.

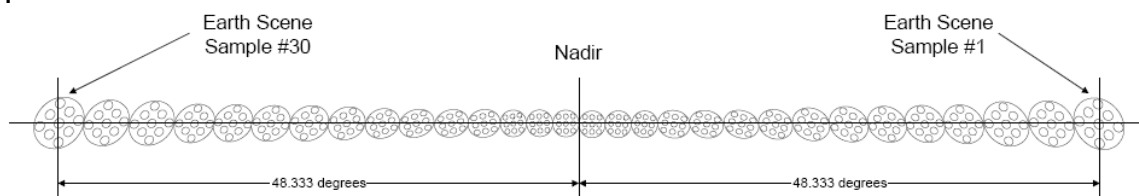

Figure 4.3-5, CrIS Scene View: 30 Steps per 8 Second Scan

After the SSM, the Telescope Module delivers incoming radiation to the Aft Optics

Module which divides the input into SWIR, MWIR, and LWIR bands with LWIR Dichroic and MWIR Dichroic beamsplitters. The Interferometer Module (IM) consists of the Beamsplitter-Compensator Assembly, the porchswing assembly moving the mirror to induce an optical path difference (OPD), the Dynamic Alignment (DA) assembly compensating for the minimal tilt between the two arms of the interferometer, the metrology laser and neon sources and detection assembly for wavelength calibration and metrology determining the OPD between the moving and fixed mirrors and the direction of the mirror movement, electronics providing command, control, and housekeeping for the interferometer, sampling the IR detectors, controlling the porchswing, DA and metrology systems, and the structure to maintain alignment between the components in the thermal and vibration environment and to interface to the sensor. The LW, MW, and SW spectral range, resolution and maximum path difference (MPD) are given in Table 4.3-1, CrIS Spectral Band Coverage and Resolution.

Table 4.3.1 CrIS Spectral Band Coverage and Resolution

Band	Spectral Range [cm ⁻¹]	Spectral Range [μm ⁻¹]	Band Width [cm ⁻¹]	Resolution [cm ⁻¹]	MPD [cm ⁻¹]
LW	650-1095	15.4-9.1	445	0.625	0.8
MW	1210-1750	8.3-5.7	540	1.25	0.4
SW	2155-2550	4.6-3.9	395	2.5	0.2

The Controller circuit card assembly (CCA) forms part of the IM Electronics. It contains servo controllers for the interferometer mechanisms: porchswing (PS), dynamic alignment x (DAX), and dynamic alignment y (DAY) and a temperature controller used to control the temperature of the interferometer's laser diode. The Controller CCA provides the PCE clock, timing, and serial command and telemetry interface. The timing function synchronizes PS travel with the PCE provided 400mS sync, generates and outputs a timing signal to the PCE that indicates proper synchronization for sampling IR data, and responds to the PCE provided reset signal for proper start up initialization. The serial command and telemetry function receives, parses, and distributes PCE generated commands and gathers telemetry data. Finally, the Controller CCA provides interferometer system control such as the DA search mode routines, proper transitioning between DA coarse acquisition and DA servo control, and health and safety monitoring and control.

The CrIS PCE houses the Instrument Flight Computer (IFC), Housekeeping CCA, Signal Processing CCA's, FireWire Command & Data Bus interface, and the Power Supply Assembly. The IFC exchanges command and data with the spacecraft over the 1394a serial interface bus and interfaces internally with the SSM and IM. In addition, the IFC controls the CrIS functions by communicating with the Housekeeping and Signal Processing CCAs and manages sensor power by switching power supplies and by providing all power supply converters with a common sync frequency. The Signal Processing CCA is comprised of three major subsystems – the Preamp Electronics, the IR Signal Processing electronics and the FIR Filter electronics – to amplify, bandpass limit, digitize, and process interferograms of scene radiance recorded by the CrIS. It also performs analog anti-alias filtering, interferogram digitization, impulse/noise detection/correction, digital FIR filtering, decimation, ZPD location estimation, generation of data quality flags, commandable analog IR gain control and the provision of key telemetry and commandable sampling electronics delay matching. There are three Signal Processing CCAs, one for each FPA of the three wavelength bands, i.e. SWIR, MWIR, and LWIR. Each FPA has 9 detectors producing 9 interferograms for each FOR. The interferogram processing is shown in Figure 4.3-6, CrIS Functional Flow of Space Processing.

The Structure Module consists of the primary sensor structure, the interface for mounting to the isolation module, the module interfaces, and the thermal control surfaces, heaters and electronics. The Deployable Cooler Cover, a retractable metalized film cover, provides contamination protection for the Passive Radiant Cooler Module. The cooler cover mounts directly to the CrIS sensor Structural Module. A pair of redundant limit switches is integrated into the cover mechanism to give positive indication of proper cover retraction and stowage. The door is controlled by the PCE.

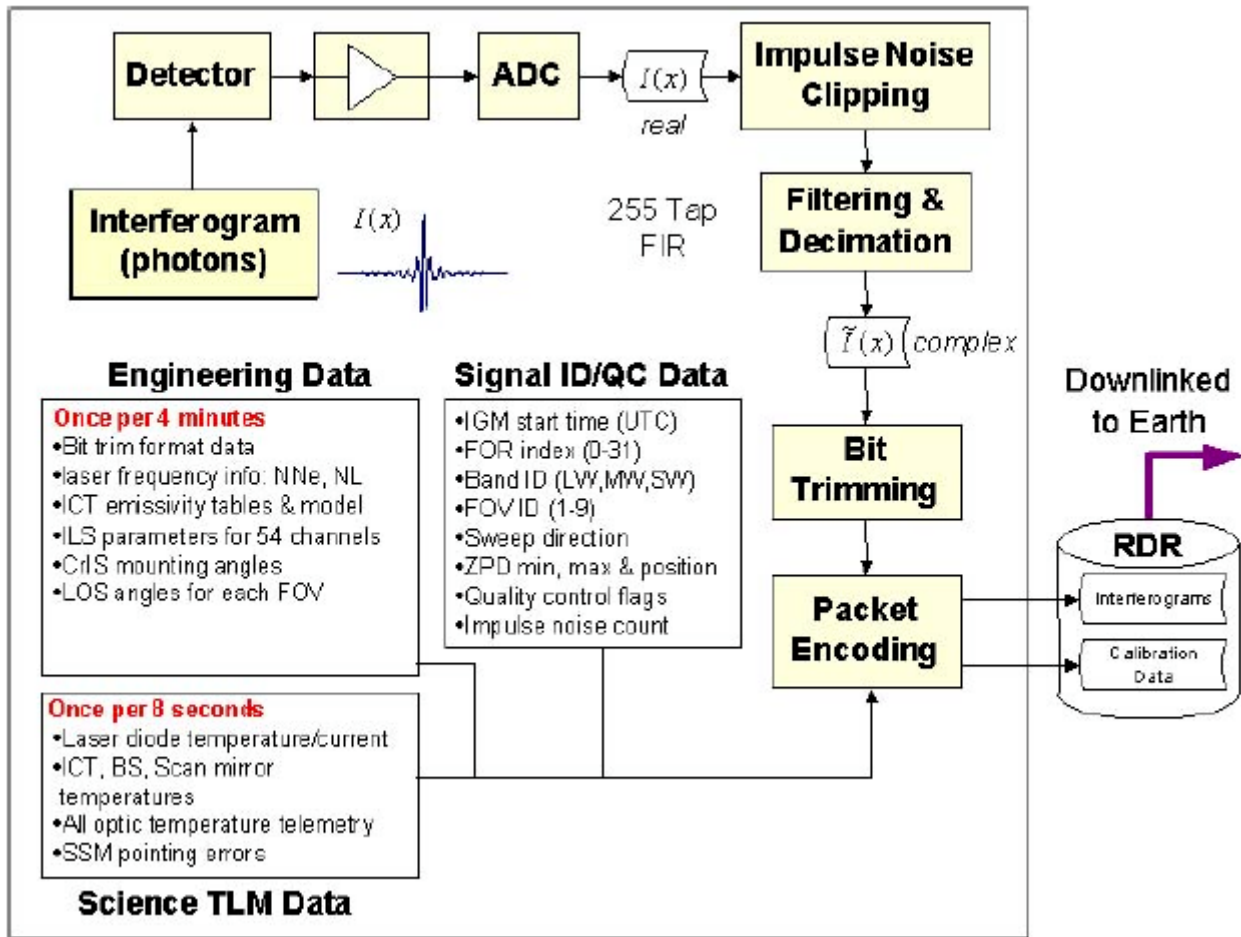

Figure 4.3-6, CrIS Functional Flow of Space Processing.

4.3.1 CrIS Instrument Modes and Packet Processing

The CrIS has 6 Sensor Modes to support NPP and NPOESS mission operations. The modes and most common transitions are described in this section..

The Processing and Control Electronics (PCE) Flight Software modes and their transitions are shown in Figure 4.3.1-1, CrIS Modes and Transitions. Software controls the instrument mode transitions. Aside from the "Sensor Safe" command, there is no single command that changes the CrIS Instrument from one mode to another.

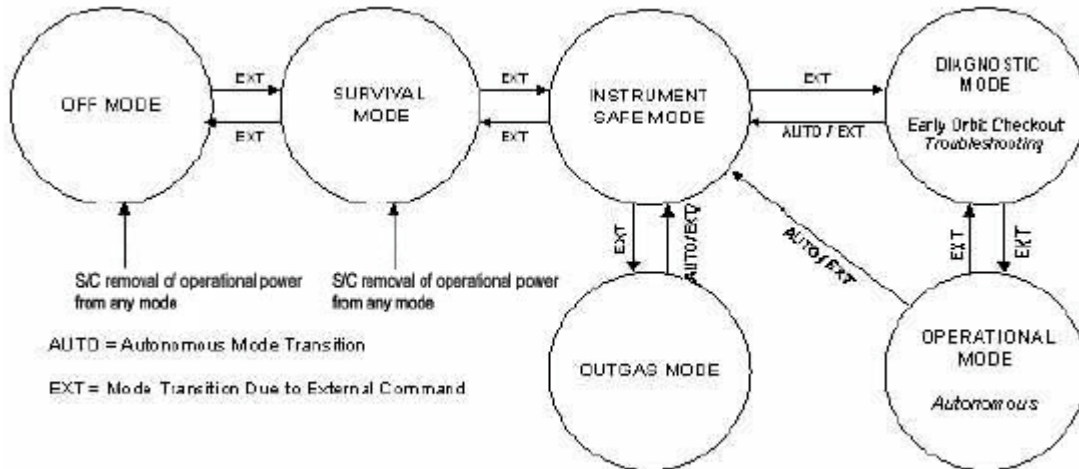

Figure 4.3.1-1, CrIS Modes and Transitions

Within these modes the functions of activation and checkout for the CrIS sensor are supported. Activation refers to CrIS turn-on, and subsequent component warm up, or cool down, to operating temperatures. Activation terminates when all instrument temperatures, biases, and currents have stabilized within specified operational limits. For CrIS, this refers to a period of time, rather than a different state of the instrument. Activation also includes the opening of the cooler door cover

4.3.1.1 Off Mode

In the OFF mode, the CrIS receives no external power for operation, including survival heater power. CrIS OFF mode is used for ground storage and transportation, launch, and spacecraft power crisis situations.

4.3.1.2 Survival Mode

In survival mode, CrIS operational power is off, and heater power is on. No APs are generated but the spacecraft may sample critical instrument temperatures via the instrument passive analog temperature sensors.

4.3.1.3 Safe Mode

In the safe mode, the CrIS sensor is partially powered up and operating. Housekeeping telemetry packets are produced and transmitted in the safe mode, however no science

or calibration data is produced.

4.3.1.4 Diagnostic Mode

When commanded into diagnostic mode, the CrIS supports the following:

1. Normal transition between the safe mode and the operational mode.
2. Early orbit checkout to verify the operation of the CrIS via an ability to transmit raw undecimated interferograms, and to dwell on selected telemetry points.
3. Support troubleshooting and/or instrument characterization.
4. Software uploads
5. Raw sensor data transmission

To support early orbit checkout and anomaly resolution, CrIS can selectively disable any on-orbit processing operation that modifies (i.e. combines or compresses) raw data in any manner.

In the diagnostic mode, CrIS transmits undecimated interferograms instead of science packets. Also, the CrIS may provide up to six channels of high data rate telemetry at a combined rate of 3200 samples per second from the Housekeeping CCA. . When in diagnostic mode, up to six channels of high rate telemetry.

CrIS accommodates the specified diagnostic mode by receipt of a command or series of commands that set up the desired diagnostic data output. Dwells are externally commanded for instrument anomaly resolution. The instrument has the capability to dwell (multiple samples per second) on particular telemetry measurands, as required to support ground diagnostic investigations. Telemetry dwell is a ground-initiated process.

4.3.1.4.1 Initialization Stabilization Submode

The CrIS Initialization sub-mode is a part of the Activation procedure. In this sub-mode, additional sequences of Built-In Tests are run, checking the functionality of the Scene Selection Module, Interferometer, and Detectors. When Diagnostic BIT is running, mission data transmission is not required, however the capability of transmitting an undecimated interferogram is provided. The BIT result is reported via telemetry to the spacecraft upon completion of the BIT.

4.3.1.5 Operational Mode

When in the operational mode, the CrIS generates mission and calibration continuously at 8 seconds per cross-track scans, and is capable of meeting all sensor performance requirements. The instrument transmits science, health, and status data to the spacecraft. The CrIS is fully functional, providing all data originating within the instrument, necessary to produce application packets.

4.3.1.6 Outgas Mode

The outgas mode, by heating portions of the CrIS sensor to elevated temperatures, purges sensor contaminants. While in outgas mode, health and status telemetry is generated, but mission data is not generated.

4.3.1.7 Packet Processing

Table 4.3.1.7-1, CrIS Application Packet Types

CDFCB-X Section	Data Mnemonic	APID	Packet Type	Generation Mode	Packet Size (octets)	Packet Frequency (packets/sec)
4.3.2 Science – Earth, Deep Space & Internal Calibration Scenes	CR_NU-L00000-001	1315 - 1395	Science	Operational Mode	2,494 (LW) 1,690 (MW) 502 (SW)	114.75 (918 packets/ 8 sec scan)
4.3.3 Science Telemetry	CR_NU-L00000-002	1289	Calibration	Operational, Diagnostic & Safe Mode	560	.125
4.3.4 Engineering Telemetry	CR_NU-L00000-003	1290	Engineering	Operational, Diagnostic & Safe Mode	7,730	.004166
4.3.5 Low Rate Data	CR_NU-L00000-004	1297 - 1314	Science	Operational Mode	244 (LW) 1,688 (MW)	Up to 76.5 (612 packets/ scan)
4.3.6 Housekeeping Dwell	CR_NU-L00000-005	1291	Dwell	Safe, Operational, Outgas & Diagnostic Mode	988	5.00
4.3.7 Scene Selection Mirror Dwell	CR_NU-L00000-006	1292	Dwell	Operational & Diagnostic Mode	1150	5.00
4.3.8 Interferometer Dwell	CR_NU-L00000-007	1293	Dwell	Operational & Diagnostic Mode	1150	5.00
4.3.9 Diagnostic	CR_NU-L00000-008	1294 - 1296	Diagnostic	Diagnostic Mode	42,108 (LW) 21,740 (MW) 11,044 (SW)	12.85 (102 packets / scan)
4.3.10 Memory Dump	CR_NU-L00000-009	1397	Memory Dump	Diagnostic Mode	Variable	When commanded
4.3.11 Instrument HK Telemetry Sub-Packets 1-8	CR_NU-L00000-010	1280 – 1287	Telemetry	Operational & Diagnostic Mode	98 1336 (1287 only)	.125
4.3.12 Launch and Early Orbit	CR_NU-L00000-011	1288	Diagnostic	Operational, Diagnostic & Safe Mode	24	1.0

The CrIS generates mission data on a regular 8-sec scan cycle. The 8-second scan is broken into forty 200 msec epochs beginning with the 8-sec synchronization pulse from the spacecraft. During proper synchronization, the pulse begins the observation of the first of thirty Earth Scenes. After 30 epochs observing the Earth, the CrIS uses one epoch to slew to the Deep Space view, two epochs to collect calibration interferograms of Deep Space, two epochs to slew to the ICT and two epochs collecting calibration inteferograms of the ICT. During the final three epochs, the CrIS transitions from observing the ICT to the first Earth Scene again. The CrIS scan sequence is shown in Figure 4.3.1-2, CrIS Normal Cross-track Scan Sequence (Timing in seconds).

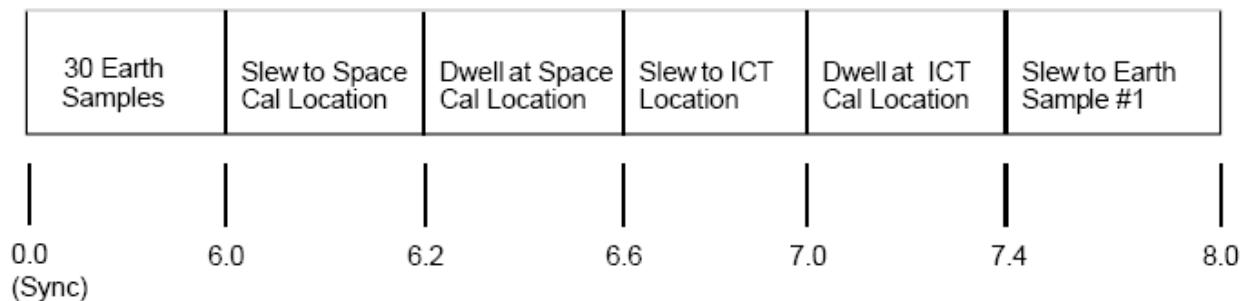

Figure 4.3.1-2, CrIS Normal Cross-track Scan Sequence (Timing in seconds)

All interferogram packets are formatted alike, though different APIDs contain Earth, Deep Space and ICT views. In Operational mode, the CrIS generates a set of 27 packets for each observing epoch. In Diagnostic Mode, only 3 packets (one per band) instead of 27 are output for each observing epoch. For interferogram packets, the UTC formatted timestamp in the secondary header indicates the time at the end of the interferogram sweep (+/- 1 msec). The time of the center of the Interferogram sweep can be determined by post-processing the UTC timestamp utilizing the timestamp bias parameter contained in the Engineering packet.

In addition to the interferogram packets, the CrIS outputs one Science Telemetry Packet one per scan, an Engineering packet every 30 scans, 8 LEO&A and 8 housekeeping telemetry packets per scan in Operational Mode. In Diagnostic Mode, the CrIS generates Dwell and Memory Dump packets every epoch (40 times per scan) when requested. The NPP C&T Handbook describes the LEO&A and Housekeeping packet

contents.

Packet formats comply with the CCSDS Standards, as tailored for NPOESS use per the FT1394 System IRD. The UTC formatted timestamp in the secondary header indicates the time the packet is generated. The packet fields are in big-endian byte order.

4.3.2 Science – Earth, Deep Space & Internal Calibration Scenes

Data Mnemonic CR_NU-L00000-001

APID	<u>APID</u>	<u>Band</u>	<u>Scene</u>
	1315 – 1323	LW	Earth
	1324 – 1332	MW	Earth
	1333 – 1341	SW	Earth
	1342 – 1350	LW	Deep Space
	1351 – 1359	MW	Deep Space
	1360 – 1368	SW	Deep Space
	1369 – 1377	LW	Internal Cal Target
	1378 – 1386	MW	Internal Cal Target
	1387 – 1395	SW	Internal Cal Target

Description

Science APs contain interferograms of the incoming infrared radiance. The interferograms are processed by the SDR algorithm, using a Fourier Transform to produce a spectrum that is then calibrated and geolocated.

The CrIS instrument performs one scan every 8 seconds. For each scan, interferograms of 30 earth scenes, 2 deep space scenes, and 2 internal calibration scenes are produced. Within each scene, or field of regard (FOR), the CrIS instrument has 9 Fields of View (FOV). A FOV is the spot on the ground viewed by each individual detector. There are three sets of detectors used for the Long Wave, Medium Wave, and Short Wave portions of the Infrared spectrum. Altogether, there are 27 interferogram data types for each scene.

The CrIS instrument assigns different APIDs to interferograms produced from earth, deep space, and internal calibration target scenes. All of these APIDs are available on HRD and SMD streams. The Long and Medium wave Deep Space and Internal Cal Target APIDs (i.e. 1342 – 1359 and 1369-1386) are also available on LRD. Long and Medium wave Earth Scenes are available on LRD as different APIDs; these are discussed in

Section 4.3.5.

Packet Size	<p>The amount of data and packet size varies by IR band. The user data fields include a status data field (18 octets), and an interferogram data field (variable). The maximum total sizes of the packet sequences are:</p> <p>LWIR: 2494 octets</p> <p>MWIR: 1688 octets</p> <p>SWIR: 502 octets</p>
Availability	<p>The science APs are generated when the CrIS is in operational mode.</p>
Frequency	<p>When enabled, there are 34 scenes sampled every scan. Since there are 27 FOV per scene (3 Bands x 9 FOV), there are 918 Science application packets produced every 8 seconds.</p>
Data Content	<p>CrIS packets include:</p> <p>Primary Header (6 octets) and Secondary Header (8 octets)</p> <p>The secondary header time stamp corresponds to the positive edge of the last 200ms Sync signal occurring prior to the sampling of the packet's data.</p> <p>These APs contain interferograms for 1305 spectral channels. The LWIR spectrum band has 713 spectral channels, the MWIR has 433, and the SWIR has 159.</p> <p>Scene samples are taken over a 200 millisecond sample period. The data is filtered, decimated, and bit trimmed to reduce the data volume transmitted without loss of information.</p> <p>The Science application packets contains:</p> <ul style="list-style-type: none"> Spacecraft ID Tag. CrIS Sensor ID or Serial Number. FOR Index (0 – 31: 30 Earth, 1 Deep Space, 1 ICT). Band Designator (LW, MW, SW). Interferometer Sweep Direction (Forward or Reverse). UTC Stamp (Start of Interferometer Sweep). Zero Path Difference (ZPD) Magnitude and Fringe Count. <p>More specific contents for CrIS Science packets are in Part 2 of this document. (Note: CrIS APIDs are in hex in Part 2.)</p>

4.3.2.1 Earth Scene Data

The fixed length (by band) packets are configurable because the number of samples is fixed for each band and the size of each sample is configurable by command. The default sizes are below and the maximum sizes are indicated above.

Table 4.3.2.1-1 CrIS Operational Interferogram Samples by IR Band

IR Band	Post Processing Bits (for each I and Q)	Number of Samples (for each I and Q)
LW	18	866
MW	17	530
SW	15	202

In Operational Mode, each IR band's interferogram samples a different number of complex numbers, per Table 4.3.2.1-1, CrIS Operational Interferogram Samples by IR Band. The bit size of each sample after filtering and decimation but before bit trimming differs between bands. These data then pass through the programmable bit trimming process. The bit trimming for each band is divided into up to 16 zones, each with its unique bit trimmed sample length. The start and stop bit of the 40-bit filter response accumulator (defining the trimmed length) and the boundary of each zone is included in the Engineering Packet. Table 4.2.3.1-2, CrIS Default Bit Trimming Output, documents the default trimmed lengths for the default zones of the LW, MW and SW packets. The bits not used in the last 16-bit word of the I data block and Q data block are zero filled.

Table 4.2.3.1-2, CrIS Default Bit Trimming Output

	LW		MW		SW	
	End Sample Index	Sample Bit Length	End Sample Index	Sample Bit Length	End Sample Index	Sample Bit Length
Zone 1	30	10	199	11	64	6
Zone 2	137	12	330	17	137	15
Zone 3	298	10	530	11	202	6
Zone 4	352	11				
Zone 5	406	12				
Zone 6	459	18				
Zone 7	514	12				
Zone 8	567	11				
Zone 9	728	10				
Zone 10	836	12				
Zone 11	866	10				
Total Interferogram Bits	9837 x 2 = 19674		6616 x 2 = 13232		1869 x 2 = 3738	
Total Interferogram Bytes (after zero fill)	1230 x 2 = 2460		828 x 2 = 1656		234 x 2 = 468	
Total Packet Bytes, including header	2460 + 14 + 20 = 2494		1656 + 14 + 20 = 1690		468 + 14 + 20 = 502	

4.3.2.2 Deep Space and Internal Calibration Data

The SSM spends two epochs at each location so these APIDs, 1342-1395, is generated twice every 8 second scan when in Operational Mode. The packet format and user data fields for these APIDs are identical to the Science Data APIDs.

4.3.3 Science Telemetry

Data Mnemonic	CR_NU-L00000-002
APID	1289 Science Telemetry
Description	The science telemetry APs contain only dynamic data supporting science mission calibration and geolocation.
Packet Size	The Science Telemetry application packet size is 560 octets.
Availability	Science Telemetry application packets are available when the CrIS instrument is in Operational Mode. When the CrIS instrument is in this mode, these packets are generated periodically. They are also available in Diagnostic and Safe Modes.
Frequency	The Science Telemetry application packet is produced once every 8-second scan.
Data Content	<p>CrIS packets include:</p> <ul style="list-style-type: none">Primary Header (6 octets) and Secondary Header (8 octets) <p>The secondary header time stamp corresponds to the positive edge of the last 200ms Sync signal occurring prior to the sampling of the packet's data.</p> <p>This packet contains Calibration Resistor temperature and ICT temperatures measured during all 40 epochs of the scan. Servo pointing errors are available when the SSM points to the 30 earth FORs. Additional fields are added to the first epoch observing the ICT.</p> <p>Specific contents for CrIS Science Telemetry packets are in Part 2 of this document. (Note: CrIS APIDs are in hex in Part 2.)</p>

4.3.4 Engineering Telemetry

Data Mnemonic	CR_NU-L00000-003
APID	1290 Engineering Telemetry
Description	The Engineering Telemetry application packets contain the CrIS instrument engineering data to support the processing of the interferogram data.
Packet Size	The Engineering Telemetry AP size is 7730 octets.
Availability	The Engineering Telemetry application packets are available when the CrIS instrument is in Operational Mode. When the CrIS instrument is in this mode, these packets are always on, they can't be turned off. They are also available in Diagnostic and Safe Modes.
Frequency	The Engineering Telemetry application packets are produced once every 30 scans, or 4 minutes.
Data Content	<p>CrIS packets include:</p> <ul style="list-style-type: none">Primary Header (6 octets) and Secondary Header (8 octets) <p>The secondary header time stamp corresponds to the positive edge of the last 200ms Sync signal occurring prior to the sampling of the packet's data.</p> <p>The extensive contents of this packet include tables of calibration target emissivity versus frequency, Instrument Line Shape (ILS) curve fitting parameters, calibration of the neon source wavelength, polarization change versus wavelength for the Earth Scene and Deep Space FORs, Science/Calibration Telemetry conversion coefficients and limits, field of view mapping parameters, bit trim parameters, jitter correction parameters and neon laser calibration data.</p> <p>Specific contents for CrIS Engineering Telemetry packets are in Part 2 of this document. (Note: CrIS APIDs are in hex in Part 2.)</p>

4.3.5 Low Rate Data

Data Mnemonic CR_NU-L00000-004

APID 1297 – 1305 LRD LW Earth Scene
1306 – 1314 LRD MW Earth Scene

Unique APIDs are designated for each of the 9 FOVs for each Earth Scene FOR for the LWIR and MWIR bands. The number of FOVs can be selected: from 1 to 9. The selected FOV are the same for both LWIR and MWIR.

Description There are two commandable modes: LRD fixed and LRD peak detection mode. In LRD fixed mode, specific FOVs are selected. In LRD Peak Detection Mode, selection of the FOV is based on the interferogram ZPD magnitude of the LWIR interferogram data.

Packet Size The LRD application packet size is band dependent. The total packet sizes are:

LWIR: 2494 octets

MWIR: 1686 octets

Availability The Low Rate Data application packets are commandable (i.e., they can be available) any time science data is produced. Science data can be produced when the CrIS instrument is in Operational Mode.

Frequency There are 34 scenes every 8-second scan. There are up to 9 FOV for each scene for the LWIR band and an identical number for the MWIR band. Therefore, there are up to 612 packets being produced every 8 seconds.

Data Content CrIS packets include:

Primary Header (6 octets) and Secondary Header (8 octets)

The secondary header time stamp corresponds to the positive edge of the last 200ms Sync signal occurring prior to the sampling of the packet's data.

The Low Rate Data application packets contain a subset of the science data (interferograms) utilizing the same data formats; see Section 4.3.2. They are broadcast to support LRD field terminals.

Specific contents for CrIS Low Rate Data packets are in Part 2 of this document. (Note: CrIS APIDs are in hex in Part 2.)

4.3.6 Housekeeping Dwell

Data Mnemonic	CR_NU-L00000-005
APID	1291 Housekeeping Dwell
Description	The Housekeeping Dwell application packet contains up to 6 telemetry parameters, called channels, sampled at 400 Hz (80 samples in 0.2 seconds). Channels sampled are #1-3 and 5-7.
Packet Size	The Housekeeping Dwell AP size is 988 octets
Availability	Housekeeping Dwell APs are generated upon command when the CrIS instrument is in one of; Safe, Diagnostic, Operational, and Outgas Modes.
Frequency	When enabled, the Housekeeping Dwell application packet is produced every 0.2 seconds.
Data Content	<p>CrIS packets include:</p> <ul style="list-style-type: none">Primary Header (6 octets) and Secondary Header (8 octets) <p>The secondary header time stamp corresponds to the positive edge of the last 200ms Sync signal occurring prior to the sampling of the packet's data.</p> <p>The application packet contains the dwell channel addresses and dwell data.</p> <p>Specific contents for CrIS Housekeeping Dwell packets are in Part 2 of this document. (Note: CrIS APIDs are in hex in Part 2.)</p>

4.3.7 Scene Selection Mirror (SSM) Dwell

Data Mnemonic	CR_NU-L00000-006
APID	1292 Scene Selection Mirror Dwell
Description	The Scene Selection Mirror Dwell application packet contains 7 SSM telemetry parameters, called channels, sampled at 400 Hz (80 samples in 0.2 seconds). Channels are numbered 1-7.
Packet Size	The Scene Selection Mirror Dwell AP size is 1150 octets
Availability	The Scene Selection Mirror Dwell application packet is commandable when the CrIS instrument is in Diagnostic and Operational Modes.
Frequency	When commanded, the Scene Selection Mirror Dwell application packet is produced every 0.2 seconds.
Data Content	<p>CrIS packets include:</p> <ul style="list-style-type: none">Primary Header (6 octets) and Secondary Header (8 octets) <p>The secondary header time stamp corresponds to the positive edge of the last 200ms Sync signal occurring prior to the sampling of the packet's data.</p> <p>The AP contains SSM dwell channel addresses and SSM dwell data, along with SSM status and error flags.</p> <p>Specific contents for CrIS SSM Dwell packets are in Part 2 of this document. (Note: CrIS APIDs are in hex in Part 2.)</p>

4.3.8 Interferometer Dwell

Data Mnemonic	CR_NU-L00000-007
APID	1293 Interferometer Dwell
Description	Interferometer dwell APs provide raw undecimated interferograms, and to dwell on 7 selected telemetry points, called channels, so as to transmit data from these points at a high rate. Channels are numbered 1-7.
Packet Size	The Interferogram Dwell application packet size is 1150 octets
Availability	The Interferogram Dwell application packet is generated on command when the CrIS instrument is in one of the, Diagnostic, and Operational, Modes.
Frequency	When enabled, the Interferogram Dwell application packet is produced every 0.2 seconds.
Data Content	<p>CrIS packets include:</p> <ul style="list-style-type: none">Primary Header (6 octets) and Secondary Header (8 octets) <p>The secondary header time stamp corresponds to the positive edge of the last 200ms Sync signal occurring prior to the sampling of the packet's data.</p> <p>The Interferogram Dwell application packet contains up to 7 IFM telemetry parameters, called channels, sampled at 400 Hz (80 samples every 0.2 seconds). The application packet contains interferometer dwell channel addresses, interferometer dwell data, and related status and error flags.</p> <p>Specific contents for CrIS Interferometer Dwell packets are in Part 2 of this document. (Note: CrIS APIDs are in hex in Part 2.)</p>

4.3.9 Diagnostic

Data Mnemonic CR_NU-L00000-008

APID	<u>APID</u>	<u>Band</u>
	1294	LW
	1295	MW
	1296	SW

Description The Diagnostic application packets contain the same data that is contained within the Science application packets. The main difference is that the data in the Diagnostic packets is not processed (i.e., filtered, decimated, or bit trimmed) within the CrIS instrument. Because the sampling of the interferogram is much finer, the CrIS limits its Diagnostic data output to one FOV per FOR; hence there is one APID per band. Each. includes 30 diagnostic Earth FORs, 2 diagnostic Deep Space FORs and 2 diagnostic ICT FORs. Operators select which FOV via command; the selection is reflected in the Diagnostic Mode Channel Select field of the Filter Status Word within the packet.

Packet Size No bit trimming is performed in Diagnostic Mode. Each interferogram sample is put into a 16-bit word, regardless of its post-processing length or A/D resolution. Thus even a sample from a 14-bit A/D is put into a 16-bit word. With every sample of uniform length, the number of samples determines the length of the packet.

Since the data in the Diagnostic packets is not processed to reduce the data volume, the individual packets are much larger than the Science packets. The Diagnostic packets consist of a Status Data field (14 octets), and an Interferogram Data field (varies by IR Band). The total sizes of the packets are:

- LWIR 42,108 octets (10519 Samples for each I and Q)
- MWIR 21,740 octets (5427 Samples for each I and Q)
- SWIR 11,044 octets (2753 Samples for each I and Q)

Availability The Diagnostic application packets are available when the CrIS instrument is in Diagnostic Mode.

Frequency

When the Diagnostic Test Mode bit of the band's DSP Hardware Control Settings field in the Housekeeping Packet is set to Normal, there are 34 scenes sampled every 8 second scan. Since there are potentially 3 APIDs per scene (one for each IR Band), there are potentially 102 Diagnostic application packets produced every 8 seconds.

If the Diagnostic Test Mode bit of a band is set to Process All frames, the CrIS outputs the APID 40 times per scan. The CrIS will exceed its allocated data rate if all three diagnostic packets are generated 40 times per scan.

Data Content

CrIS packets include:

Primary Header (6 octets) and Secondary Header (8 octets)

The secondary header time stamp corresponds to the positive edge of the last 200ms Sync signal occurring prior to the sampling of the packet's data.

The Diagnostic packets contain scene samples over a 200 millisecond period. There are three unique APID numbers assigned to each of the IR Bands (LWIR, MWIR, and SWIR). These APIDs capture the Earth, deep space, and internal calibration target scenes. The Diagnostic packet captures only one of the nine fields of view within the FOR, or scene sample. The FOV captured in the Diagnostic packet is configurable and is reported in the Status field of the packet.

The Diagnostic packet formats differ from the other Interferogram packets in two ways. First, the I data and Q data block sizes are different. Second, the "Number of I words after bit trimming" in the Operational Interferogram packet is unnecessary and not included in the Diagnostic Packet

Specific contents for CrIS Diagnostic packets are in Part 2 of this document. (Note: CrIS APIDs are in hex in Part 2.)

4.3.10 Memory Dump

Data Mnemonic	CR_NU-L00000-009
APID	1397 Memory Dump
Description	<p>Memory Dump APs provide a means for downlinking image segments of the CrIS memory.</p> <p>CrIS memory types that can be dumped include the following:</p> <ul style="list-style-type: none">01 – IFC SRAM02 – Boot ROM03 – Program EEPROM04 – BAE PCI Bridge Chip05 – Aux Bridge Chip06 – Housekeeping CCA07 – Signal Processor LW08 – Signal Processor MW09 – Signal Processor SW0A – Firewire CCA A0B – Firewire CCA B0C – APID Table0D – SSM EEPROM0E – IM EEPROM0F – 1394 Fault Log
Packet Size	<p>The total size of the Memory Dump application packets can be up to 32,792 octets maximum (including CCSDS headers and dump header), but vary according to the memory type being dumped. If the requested size of memory to dump is too large, then it will be sent in multiple packets at 200ms increments.</p> <p>However, .dumps of the SSM and IM EEPROM are limited in size to 128 bytes; multiple requests are necessary for larger dumps.</p>
Availability	The Memory Dump application packets are commandable when the CrIS instrument is in the Diagnostic Mode.
Frequency	The Memory Dump application packets are produced when commanded. When the dump size is larger than a single packet size, a memory dump packet will be sent every .2 seconds.
Data Content	<p>CrIS packets include:</p> <ul style="list-style-type: none">Primary Header (6 octets) and Secondary Header (8 octets) <p>The secondary header time stamp corresponds to the</p>

positive edge of the last 200ms Sync signal occurring prior to the creation of the packet data. So the timestamps increase in multiple-packet dumps since each packet is stamped with the time of its generation

The Memory Dump application packets contain the memory dump type, dump sequence ID, dump sequence total, dump address, and memory dump data.

All memory dumps that include SRAM DMA buffers will contain 0xCC where the DMA buffer memory would be.

Specific contents for CrIS Memory Dump packets are in Part 2 of this document. (Note: CrIS APIDs are in hex in Part 2.)

4.3.11 Instrument HK Telemetry Sub-Packet

Data Mnemonic	CR_NU-L00000-010
APID	1280 – 1287
Description	These packets provide numerous hardware and software status settings
Packet Size	98 octets
Availability	Operational and Diagnostic Modes
Frequency	.125 packets/second
Data Content	CrIS packets include:

Primary Header 6 octets

Secondary Header 8 octets

The secondary header time stamp corresponds to the positive edge of the last 200ms Sync signal occurring prior to the sampling of the packet's data.

These packets include S/C interface status, SSM interface status, MM and IFM interface status, sensor status, Flight Software exception status. 1394 Bus status and telemetry/command success counts.

Specific contents for CrIS Housekeeping Telemetry sub-packets are in Part 2 of this document. (Note: CrIS APIDs are in hex in Part 2.)

4.3.12 Launch and Early Orbit Packet

Data Mnemonic	CR_NU-L00000-011
APID	1288
Description	These packets provide CrIS initialization, power and thermal status settings and data
Packet Size	24 octets
Availability	Operational, Diagnostic & Safe Modes
Frequency	1.0 packet/second
Data Content	CrIS packets include: Primary Header (6 octets) and Secondary Header (8 octets) The secondary header time stamp corresponds to the positive edge of the last 200ms Sync signal occurring prior to the sampling of the packet's data. These packets include PCE Power Up status, converter currents, SSM voltage and current, Stage 4 cooler temperature, and telescope temperature #1. Specific contents for CrIS LEO&A sub-packets are in Part 2 of this document. (Note: CrIS APIDs are in hex in Part 2.)

4.4 Ozone Mapping and Profile Suite

4.4.1 Instrument Overview

The OMPS provides NPOESS users with data products describing the vertical, horizontal, and temporal distribution of ozone in the Earth's atmosphere.

The Nadir Sensor observes ultraviolet and visible light from 250 nm to 1000 nm. Unlike the other NPOESS sensors, the OMPS does not scan across nadir. Its nadir instrument has a fixed field of view $110^\circ \times 0.3^\circ$ centered at nadir, with two spectrometers to determine the total column ozone and ozone profile concentrations. Charge-Coupled Devices (CCDs) within the sensors integrate the spectral and spatial distribution of radiation from 250 nm to 1000 nm.

Mission data obtained from the OMPS produce the following NPP/NPOESS EDR:

Ozone Total Column and Vertical Profile

The following VIIRS and CrIS EDRs are used in generating the OMPS EDRs:

- Temperature Profile (CrIS)
- Pressure Profile (CrIS)
- Cloud Top Pressure (VIIRS)
- Cloud Cover/Layers (VIIRS)
- Snow Cover/Depth (VIIRS)
- Fresh Water Ice (VIIRS)
- Ice Concentration (VIIRS)

4.4.1.1 Instrument Function

The OMPS hardware segment consists of the Nadir Sensor and Main Electronics Boxes (MEB).

The Nadir Sensor contains two spectrometers to determine the total column ozone and

ozone profile concentrations. The two spectrometers share a common telescope that has a 110 deg x 0.3 deg field-of-view. The total ozone spectrometer uses the full FOV of the telescope and the ozone profile spectrometer uses only a portion of the telescopes FOV.

Each spectrometer uses a 364 x 780 pixel CCD to obtain the ozone data. Only a portion of each CCD is transmitted in the science and the calibration packets. Thermal Electric Coolers (TECs) and heaters maintain the CCDs at a stable temperature.

The CCD integration times and the charge transfer from the CCD to the Analog-to-Digital Converter (ADC) are controlled using a Timing Pattern Generator (TPG). Each OMPS Sensor has its own dedicated TPG. Integration times, pixel binning, and pixel sampling on the TPG are programmable. Programs for the TPGs are resident in the MEB static memory and are downloaded to the TPGs after Flight Software has been commanded to do so. Multiple TPG programs can be resident in the MEB to allow for multiple in-flight CCD operational modes.

The Nadir sensor has calibration lamps and calibration mechanisms. The calibration mechanism can move one of two reflective diffusers into the OMPS FOV to measure solar irradiance. LEDs and diffusers are used to calibrate the spectrometers. The onboard LED lamps are used to check the linearity and dark current of the CCDs when the OMPS is in the shadow of the Earth with the aperture door closed.

The MEB contains the OMPS CPU, ADCs, TPGs, housekeeping and power supply boards. The MEB provides the electrical interface to the spacecraft. The housekeeping board interfaces with the Nadir Sensor and provides additional telemetry generated in the MEB itself.

4.4.2 Modes and Packet Processing

The OMPS implements the following modes.

- Off Mode
- Activation
- Boot-up
- Operational Mode
- Diagnostic Mode

Safe-Hold Mode
Survival Mode

The normal transition from full off to full operational mode progresses through the Boot-up, Safe-Hold, and Activation modes. Early orbit checkout occurs in the OPERATIONAL mode. The next three represent modes for abnormal conditions. OPERATIONAL mode also includes autonomous functionality. The OMPS does not have a separate calibration mode, but performs calibrations as part of operational mode as discussed below. Figure 4.2.2-1, OMPS Modes and Mode Transitions, is the top-level transition diagram for the OMPS.

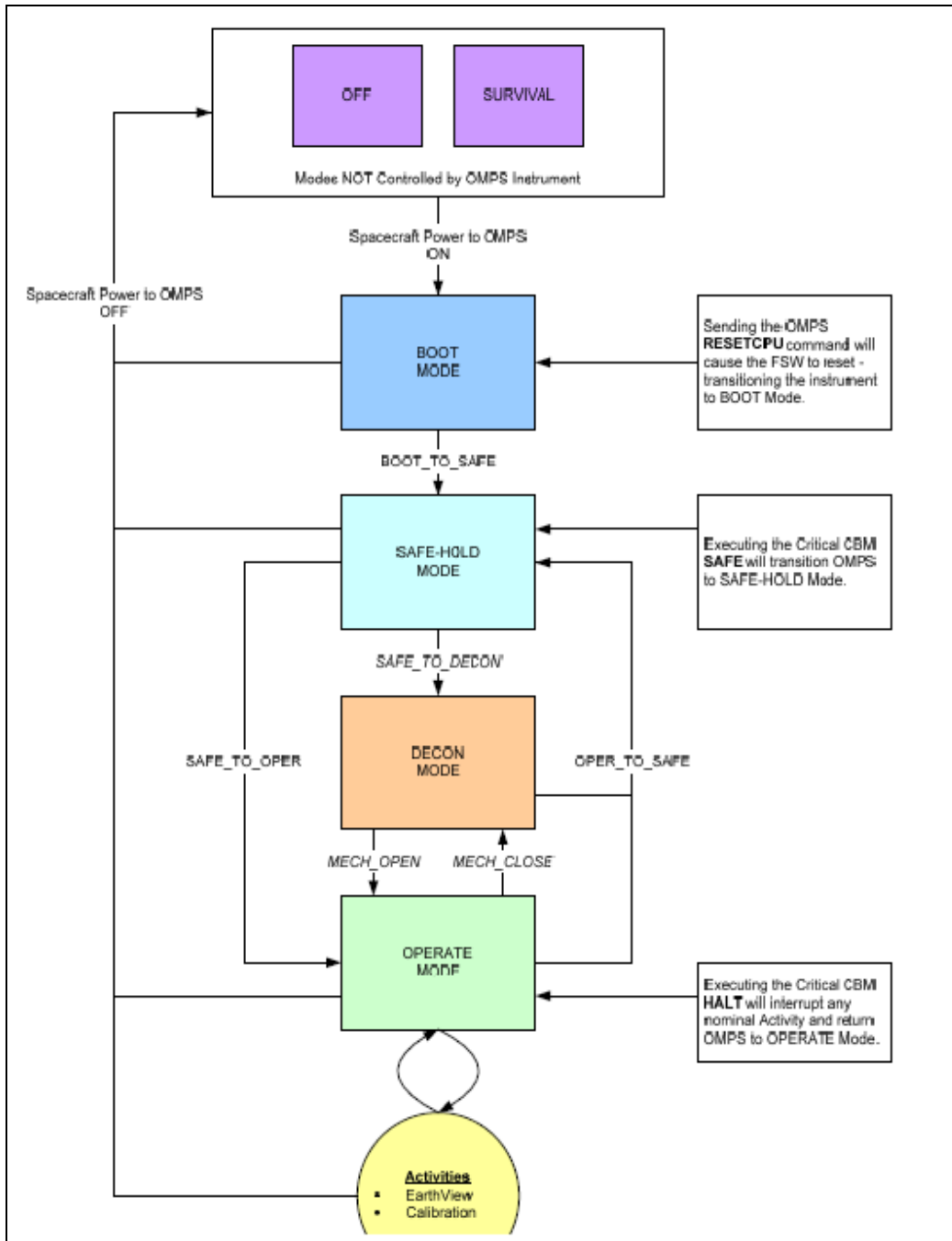

Figure 4.2.2-1, OMPS Modes and Mode Transitions

4.4.2.1 Off Mode

In the instrument Off mode, the OMPS receives no external power. This includes survival heater power and operational power. No mission data is output in Off Mode. The instrument is in Off mode during launch and in the worst-case spacecraft power

crisis situations once on orbit.

4.4.2.2 Activation Mode

Activation Mode is a transitional mode including sensor turn-on, and subsequent sensor component warm up, or cool down, to the operating temperatures. Activation Mode terminates when all instrument temperatures, biases, and currents have stabilized within specified operational limits. Mission data packet types are sent before exiting Activation Mode to prepare for normal science data acquisition.

4.4.2.3 Boot-up

Boot-up mode is a transitional mode. This means the instrument passes through Boot-up on its way to Safe-Hold mode after leaving Off or Survival modes. Boot-up mode is defined as a separate mode since the boot process can take several seconds to complete before entering SAFEHOLD mode. No mission data is output in Boot-up Mode.

4.4.2.4 Operational Mode

When in OPERATIONAL mode, the OMPS collects data from the Nadir sensor and performs the necessary data reduction before forwarding the data to the spacecraft. In addition to sensor operations, the OMPS performs the collection and monitoring of critical telemetry items output to the spacecraft. The OMPS is capable of autonomous operation in this mode. Autonomous operation refers to running for an extended period of time during which there are no commands coming from the ground or the spacecraft.

The OMPS has two possible states within Operational Mode: Earth Observation State and Calibration State.

In Earth observation operations, ozone data is reported in the Nadir Total Column packet and the Nadir Profile packet. The Nadir sensor operates in an "ON" state during the approximately 50 minutes of each orbit when their fields of view are sunlit. Figure 4.4.2.4-1, OMPS Time Marker Description for a Descending Orbit, shows the important times during an OMPS orbit (the Nadir Sensor is "ON" from t3 to t1). When a sensor is

not “ON”, it is in a “STANDBY” state (tpg program stopped, power on). During Earth observation, the OMPS processor in the MEB runs throughout the NPP orbit (100% duty cycle).

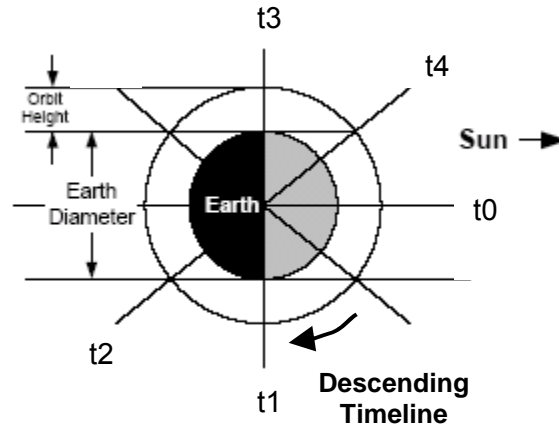

Figure 4.4.2.4-1, OMPS Time Marker Description for a Descending Orbit

Calibration state is used to collect solar calibration data, dark signal data, and linearity correction data required on a weekly basis. It is defined as a separate state since the mechanisms and calibration lamps are configured differently than they are in OPERATIONAL mode.

The configuration of the instrument in the Calibration state is as follows:

Nadir diffuser wheel is commanded to the appropriate positions (if NTC or NP solar calibration is being performed).

Nadir Total Column calibration lamp is turned ON (if NTC linearity calibration is being performed).

Nadir Profiler calibration lamp is turned ON (if NP linearity calibration is being performed).

CCD linearity and dark current calibration measurements are nominally performed when the OMPS is in the shadow of the Earth with the aperture door closed during each calibration orbit.

4.4.2.5 Diagnostic Mode

DIAGNOSTIC mode is used to perform maintenance of the OMPS Flight Software, and

to perform any special testing required for troubleshooting on-orbit anomalies. The OMPS does not provide full functional performance, but performs the following tasks:

- Receiving and processing software uploads.

- Dumping the contents of onboard memory.

- Performing self-tests of the instrument.

- Collecting mission and calibration data for anomaly resolution purposes.

- Collecting and reporting dwell data.

4.4.2.6 Safe-Hold Mode

In the event of certain anomalous conditions, the spacecraft or OMPS flight software places the instruments into Safe mode. In Safe-Hold mode, the OMPS health and status data are collected and transmitted to the spacecraft. Mission and calibration data are not transmitted to the spacecraft.

4.4.2.7 Survival Mode

Survival mode is a low power mode entered when the spacecraft identifies a critical power shortage. The instrument maintains its temperature above the survival temperature using survival heaters controlled by a passive thermostat. There is no operational power in this mode. No mission data is output in Activation Mode.

4.4.2.8 Packet Processing

The OMPS application packets are shown below in Table 4.4.2.8-2, OMPS Application Packet Types.

Table 4.4.2.8-1, OMPS Application Packet Types

CDFCB-X Section	Data Mnemonic Data Type	APID	Packet Type	Availability	Packet Size (octets)	Frequency (packets/sec)
4.4.3 Dwell Telemetry	OM_NU-L00000-002	549	Dwell	Operational & Diagnostic Mode	244	Aperiodic
4.4.4 FSW Bootup	OM_NU-L00000-003	550	FSW Bootup Status Frame	Boot-up Mode	192	Aperiodic
4.4.5 Table/Memory Dump	OM_NU-L00000-004	556	Memory Dump	Operational & Diagnostic Mode	4,194,304	Aperiodic
4.4.6 Science – NTC Earth View Data	OM_NU-L00000-005	560	Science	Operational Mode	29,448	0.134
Diagnostic NTC Earth View Data		576	Diagnostic	Diagnostic Mode	29,448	Aperiodic
4.4.7 Science - NPR Earth View Data	OM_NU-L00000-006	561	Science	Operational Mode	760	0.027
Diagnostic NPR Earth View Data		577	Diagnostic	Diagnostic Mode	567,984	Aperiodic
4.4.8 NTC Calibration Data	OM_NU-L00000-009	564	Calibration	Operational Mode	1,135,824	Aperiodic
Diagnostic NTC Calibration Data		580	Diagnostic	Diagnostic Mode	1,135,824	Aperiodic
4.4.9 NP Calibration Data	OM_NU-L00000-010	565	Calibration	Operational Mode	567,984	Aperiodic
Diagnostic NP Calibration Data		581	Diagnostic	Diagnostic Mode	567,984	Aperiodic
4.4.10 Health & Status	OM_NU-L00000-012	544	Housekeeping	Operational & Diagnostic Mode	968	0.20
4.4.11 LEO&A Housekeeping Data	OM_NU-L00000-013	545	Housekeeping	Operational & Diagnostic Mode	27	0.20
4.4.12 Test Telemetry	OM_NU-L00000-014	546	Test	NA	8	Varies

In the following sub-sections detailing the OMPS packets, the "Typical Science Data Size" is provided as a nominal value. The actual size, as well as the downlink rate, can vary depending upon the timing pattern used for the particular data collection.

These sections also refer to the 'OMPS Header' as part of the packet content. This is designed for very large OMPS APIDs that require more than 256 packets. Because the total number of packets indicator in the CCSDS secondary header is an 8 bit field, RDRs that exceed 256 total packets must be handled as multiple sequences, i.e. multiple groups of 256 packets. The OMPS header provides a way to keep track of these groups.

The OMPS header fields are added at the beginning of the data field, immediately following the CCSDS secondary header, in the first packet of a packet group. The key OMPS header fields are the Cont Count and the Cont Flag. The Cont Count contains the total number of groups remaining minus 1. This is set in the first packet of each group, and decrements by 1 in the first packet of each subsequent group, counting down to zero at the beginning of the last group. It is not relevant in middle and last packets. The Cont Flag is also applicable only in the first packet of a group. This flag, when sent to 1, indicates that this is a continuation packet in a grouped sequence. An example in Table 4.2.8-2, OMPS Header Example, illustrates the key secondary heading field values when three groups of packets are required.

Table 4.2.8-2, OMPS Header Example

Group of 256	Packet	Packet Sequence Count	Cont Count	Cont Flag
FIRST GROUP	First	255	2	0
	Middle		n/a	n/a
		n/a	n/a
	Last (256 th)		n/a	n/a
SECOND GROUP	First	255	1	1
	Middle		n/a	n/a
		n/a	n/a
	Last (256 th)		n/a	n/a

THIRD/LAST GROUP	First	# remaining - 1	0	1
	Middle		n/a	n/a
		n/a	n/a
	Last (# remaining)		n/a	n/a

Since the data in multiple grouped packets belong to a single CCD image, the secondary header timestamps are identical in all of the first packets in a multiple grouped packet. The time in the secondary header is not the time of observation for packets with CCD data; see the explanation in the Science Data section to derive the observation time from the secondary header. All fields in the OMPS data packets are big endian.

4.4.3 Dwell

Data Mnemonic	OM_NU-L00000-002
APID	549 Dwell Telemetry
Description/ Purpose	Dwell telemetry packet containing values sampled at a rate faster than available through Health & Status Data Records.
Packet Size	Total Packet Size (octets): 244 Typical Science Data Size (octets): No Science Data
Availability	Operational & Diagnostics Mode
Frequency	Generation Period (sec): Aperiodic Downlink Rate (Hz): Aperiodic When commanded, dwell packets are produced once per second.
Data Content and Data Format	Each dwell packet is 244 octets, and contains a secondary header. The application data field starts with a header, followed by 16 telemetry points. The 16 telemetry points are sampled at the same rate that engineering data are collected but output more often than engineering data. The packets are formatted as follows: OMPS Header <ul style="list-style-type: none"> • 2 octets: RDR Version • 1 octet: Packet Sequence Count – 1 • 1 octet: Cont Flag (Beginning of RDR flag) Dwell Point 1

- 2 octets: Dwl 1 Table ID
- 4 octets: Dwl 1 Offset
- 4 octets: Dwl 1 Address
- 4 octets: Dwl 1 Value

Dwell Points 2-16 repeat fields shown for Dwl 1 for Dwl 2-16

4.4.4 FSW Bootup

Data Mnemonic	OM_NU-L00000-003
APID	550 FSW Bootup Status Frame
Description/ Purpose	<p>The FSW Bootup Status Frame application packet containing status information generated by the flight software (FSW) during boot up. It is designed to provide insight into the boot up and initialization phase of the FSW. In the event the FSW does not boot correctly, this status frame could contain valuable information needed by the ground in troubleshooting the problem.</p> <p>IMPORTANT: Changes to the format of the Diagnostic application packet directly impact the Ozone Mapping and Profile Suite (OMPS) FSW. Unlike other application packets this one is generated at the lowest levels of the OMPS FSW, which means the FSW has hard-coded the format. If new sections are added to this application packet, the OMPS FSW omeps_init.c file must be updated.</p>
Packet Size	<p>Total Packet Size (octets): 192</p> <p>Typical Science Data Size (octets): No Science Data</p>
Availability	Bootup Mode
Frequency	<p>Generation Period (sec): Aperiodic</p> <p>Downlink Rate (Hz): Aperiodic</p>
Data Content and Data Format	<p>Secondary Header</p> <p>Application Data</p> <ul style="list-style-type: none"> - OMPS Header <ul style="list-style-type: none"> 2 octets: RDR Version 1 octet: Cont Count (is Packet Sequence Count – 1) 1 octet: Cont Flag (Beginning of RDR Flag) - Sensor ID Info: 7 octets - Fault Status Info: 165 octets; these include: <ul style="list-style-type: none"> Number of Unreported Faults: 2 octets Next fault sequence number: 2 octets Core File Present Flag: 1 octet Data for 10 most recent faults; for each fault this includes: <ul style="list-style-type: none"> Seq #: 2 octets Fault Code: 4 octets File #: 4 octets Line #: 2 octets Parameter #: 4 octets

4.4.5 Table/Memory Dump

Data Mnemonic	OM_NU-L00000-004
APID	556 Table/Memory Dump Data
Description/ Purpose	<p>Table/Memory Dump application packets containing onboard memory contents from either volatile (RAM) or non-volatile (Flash) memory.</p> <p>NOTE: The table/memory contents are considered the "science" data for this application packet, and, therefore, the Science Data Size is variable for every Dump application packet. Even though the Science Data Size is variable, it is set to its maximum possible value (4 MB) for documentation purposes.</p>
Packet Size	<p>Total Packet Size (octets): 4,194,304. This is the maximum amount of the memory or table data that can be dumped, and does not include headers. Because the Packet Sequence Count field in the grouped packet secondary header is an 8 bit field, the number of CCSDS packets in a group is limited to 256. Therefore this total dump would require 17 groups of 256 packets. (Refer to Section 2.1.1, Application Packet Structure for the details regarding segmented packets.)</p>
Availability	Operational & Diagnostics Mode
Frequency	Generation Period (sec): Aperiodic; when commanded. Downlink Rate (Hz): Aperiodic
Data Content and Data Format	<p>1st packet in a group</p> <p>Secondary Header – contains the time the first packet is generated. For a large dump requiring multiple groups of packets, the first packet of each group will repeat this time stamp.</p> <p>Application Data</p> <ul style="list-style-type: none">- OMPS Header<ul style="list-style-type: none">2 octets: RDR Version1 octet: Cont Count-1 (For groups of packets, this is remaining groups-1 in dump)1 octet: Cont Flag (Beginning of RDR Flag)- Sensor ID Info: 7 octets- Table Dump Info: 11 octets- Memory Data: up to 986 octets <p>Middle & Last Packet in group: Application Data is Memory Data: 1018 octets</p>

4.4.6 Science – Nadir Total Column Earth View

Data Mnemonic	OM_NU-L00000-005
APID	560 Nadir Total Column Earth View Data 576 Diagnostic Nadir Total Column Earth View Data
Description/ Purpose	<p>The Nadir Total Column Earth View application packet containing earth observation data collected by the Total Column CCD. This application packet contains OMPS and Nadir Sensor health and status telemetry that is required to process the CCD data, followed by Nadir Total Column CCD data.</p> <p>The Diagnostic Nadir Total Column Earth View Data is the corresponding diagnostic version of the science packet, used when warranted to troubleshoot anomalies. The diagnostic packet size is configurable. Its structure is the same as the operational NTC Earth View packet, although the amount of science data may vary.</p>
Packet Size	Total Packet Size (octets): 29,448, in a group of segmented CCSDS packets. Typical Science Data Size (octets): 29,304
Availability	560 - Operational Mode 576 – Diagnostic Mode
Frequency	Generation Period (sec): 7.488 The diagnostic packet is aperiodic. It is output as needed to resolve anomalies.
Data Content and Data Format	1 st packet in a group Secondary Header – contains the time the first packet is generated. Application Data - OMPS Header 2 octets: RDR Version 1 octet: Cont Count-1 1 octet: Cont Flag (Beginning of RDR Flag) - Sensor ID Info: 7 octets - Engineering Data 110 octets - Science Data: 887 octets Middle & Last packet in the group: Application Data is Science Data: 1018 octets/packet

Each science packet contains the health and status telemetry that is required to process the CCD data followed by CCD data.

The CCD has two mirror image halves that operate identically. Each half has a photo sensitive region extending 340 columns by 370 rows and a light shielded region 340 columns by 390 rows large. The extra 20 rows in the light shielded region are over-scanned rows containing only the smear signal and are used to subtract image transfer smear signal from the main image after the entire contents have been read out. To accommodate the on-chip charge-to-voltage conversion amplifiers, the serial CCD needs to be 12 pixels longer on each end than the CCD size. Therefore, the total length of a single line as read off from the imager will be 364 (i.e., 12 + 340 + 12) pixels. The extra 24 pixels (12 leading + 12 lagging) are used during calibration to determine the zero-input offset of the system. They are not currently included in the downlinked data during normal science operations.

Rows and columns are defined relative to the physical structure of the CCD and relate to the operation of the CCD; see Figure 4.4.6-1, OMPS CCD Block Diagram. Since the OMPS CCD has two mirror image halves the output amplifiers are on opposite ends. The output amplifiers are connected by the readout CCD register. The rows and columns are defined relative to the output amplifiers and readout CCD register. The rows are parallel to the readout CCD register. The rows are transferred as a whole into the readout CCD register by a parallel transfer. The columns are perpendicular to the readout CCD register. The columns are read out one at a time through serial transfers of the readout CCD register.

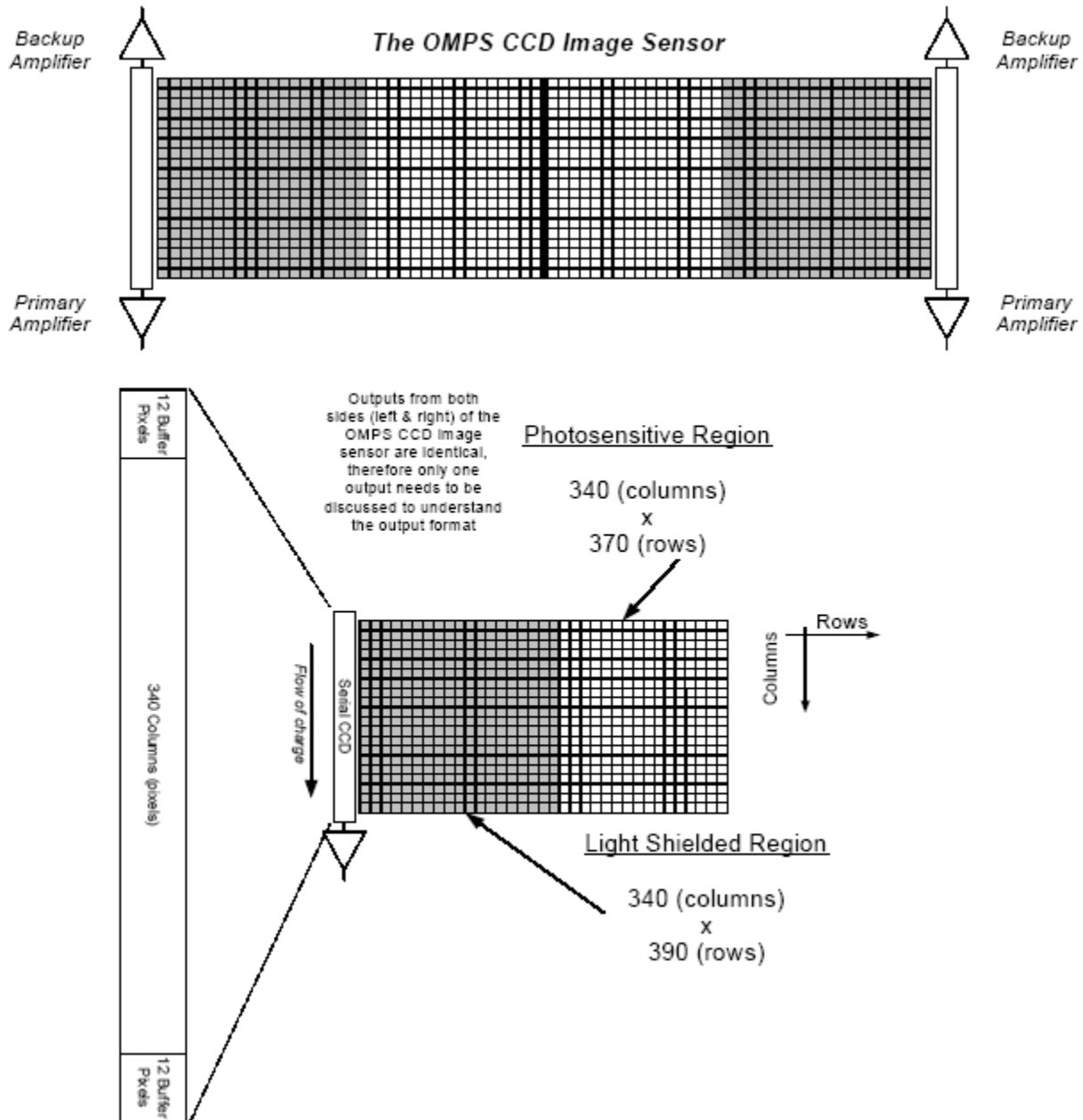

Figure 4.4.6-1, OMPS CCD Block Diagram

Every OMPS image comes from an image profile. The image profile number and any associated timing pattern, sample table, linearity correction table, and gain correction table are reported in OMPS image packets. The OMPS uses sample tables to bin CCD pixels into macro-pixels and to exclude bad pixels. If all the CCD pixels in a given macro-pixel go bad on orbit, the number of macro-pixels in the OMPS CCD data may be reduced, changing the size of the OMPS CCD data within any of the OMPS science,

calibration, and diagnostic packets. It is also possible for the packets to contain all CCD pixels with no binning by a sample table. When a sample table is not used, the CCD data are framed in the packet by four-octet Hardware (HW) Start and End Tags. The CCD images described below are those baselined by OMPS at the time of delivery for NPP integration. The size of the packets can be expected to change on-orbit due to changes in the sample table. Since calibration and diagnostic packets contain multiple types of images, each with a different size, a generic description is given for them and the size is left indefinite.

A timestamp for each image is present in two separate fields in each OMPS image packet: The Start of Scan field of the packet secondary header and the Last_IMG TLM set in the first packet before the CCD data. This timestamp does not correspond to the start of observation for the image, but instead corresponds to a time after all image data has been observed and transferred into the processor. In order to correctly geolocate and use the image data in ground processing, the start of image time must be used. Table 4.4.6-1, OMPS Timestamp Offset, below provides the offset in ms from the timestamps in the AP to the start of observation for the image. The data is organized by APID and Profile ID.

Table 4.4.6-1, OMPS Timestamp Offset

APID	Description	Profile IDs	Offset per image (ms)
560	NTC EV	0	8727.6
561	NP EV	0	39437.7
564	TC Solar	21, 22, 23, 24, 25, 26, 27	6047.9
564	TC Lamp FF	16	NA
564	TC Lamp ST	18	NA
564	TC Dark 1 FF	12	NA
564	TC Dark Coadd FF	11	NA
565	NP Solar	20	5779.3
565	NP Lamp FF	15	NA
565	NP Lamp ST	17	NA
565	NP Dark 1 FF	1	NA
565	NP Dark Coadd FF	10	NA

The Nadir TC uses both halves of the CCD. The TC image is aligned with the spectral dimension in columns (each column corresponds to a different spectral wavelength) and the spatial dimension in rows (each row corresponds to a different cross-track spatial

location). The TC produces useful data from almost all of the CCD rows, but uses only about two thirds of the columns. The data is temporally co-added and binned in the spatial dimension. The number of pixels required in the spatial dimension is derived from the minimum horizontal cross-track FOV of 110 degrees. The number of pixels in the spectral dimension is based on the required spectral range, the spectral scale of the instrument, the uncertainty in the spectral scale, and the alignment of the focal plane to the spectral range.

The TC image is taken from a 198 x 740 pixel area of the CCD image: 198 pixels in the spectral column and 700 pixels in the spatial row. There are 2 sets of 20 over-clocked rows of which the center 16 are used. Binning is performed in the spatial dimension centered about the nadir pixel column. The nadir row is determined based on instrument to spacecraft mounting alignment. Binning in the spatial dimension is 20:1 with 17.5 bins on each side of the nadir bin. There is one over-clocked bin generated for each half of the CCD. See Figure 4.4.6-2, OMPS Total Column On-Orbit Windowing and Spatial Binning.

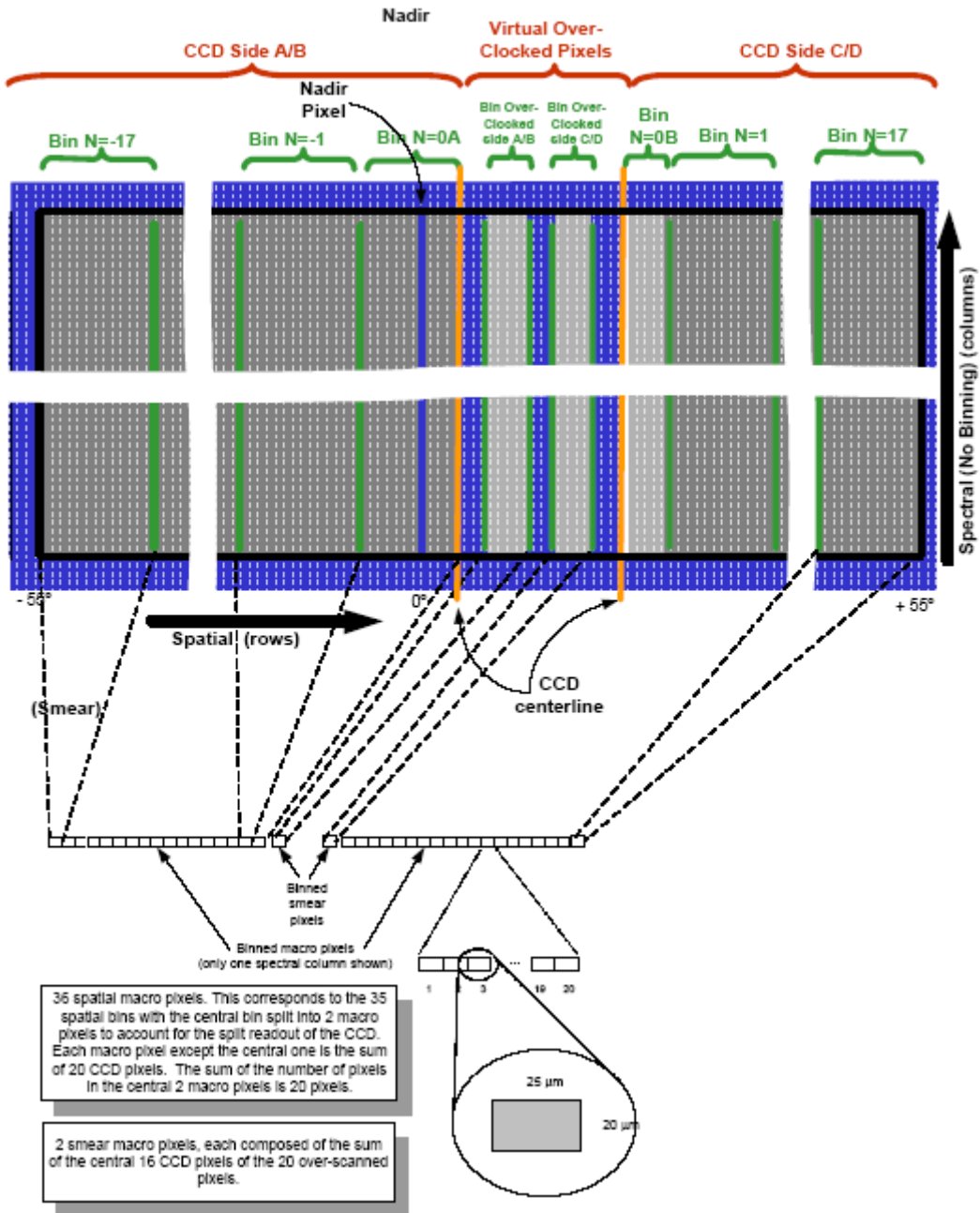

Figure 4.4.6-2, OMPS Total Column On-Orbit Windowing and Spatial Binning

4.4.7 Science - NPR

Data Mnemonic	OM_NU-L00000-006
APID	561 Science – NPR Earth View Data 577 Science – Diagnostic NPR Earth View Data
Description/ Purpose	Nadir Profiler application packet containing earth observation data. This application packet contains OMPS and Nadir Sensor health and status telemetry followed by normal operations Nadir Profiler CCD data. The Diagnostic NPR Earth View Data is the corresponding diagnostic version of the science packet, used when warranted to troubleshoot anomalies. The diagnostic packet size is configurable. Its structure is the same as the operational NPR Earth View packet, although the amount of science data may vary.
Packet Size	Science Packet: Total Packet Size (octets): 760 Typical Science Data Size (octets): 616 Diagnostic Packet: Total Packet Size (octets): 567,984 Typical Science Data Size (octets): up to 567,840
Availability	561 - Operational Mode 577 – Diagnostic Mode
Frequency	Generation Period (sec): 37.44 The diagnostic packet is aperiodic. It is output as needed to resolve anomalies.
Data Content and Data Format	Secondary Header Application Data - OMPS Header 2 octets: RDR Version 1 octet: Cont Count (is Packet Sequence Count – 1) 1 octet: Cont Flag (Beginning of RDR Flag) - Sensor ID Info: 7 octets - Engineering Data 117 octets - Science Data: 616 octets

The Nadir Profiler (NP) only uses one half (the A/C half) of the CCD and is aligned the same way as the TC with the spectral dimension in columns and spatial dimension in rows. Each column corresponds to a different spectral wavelength and each row a

different spatial location. The number of pixels that are required in the spatial dimension is derived from the 250 km swath width requirement. The number of pixels in the spectral dimension is based on the required spectral range, the spectral scale of the instrument, the uncertainty in the spectral scale, and the alignment of the focal plane to the spectral range.

The NP image data is taken from a 154 row x 96 column pixel area of the light sensitive portion of the CCD. Binning is performed in the spatial dimension centered about the nadir pixel row. Again, the nadir row is determined based on instrument to spacecraft mounting alignment. There is no binning in the spectral dimension. There is one over-clocked bin generated for the half of the CCD in use. The center 16 (of 20) rows are binned spatially with no binning of spectral over-clocked rows. See Figure 4.4.7-1, OMPS Nadir Profile On-orbit Windowing and Spatial Binning.

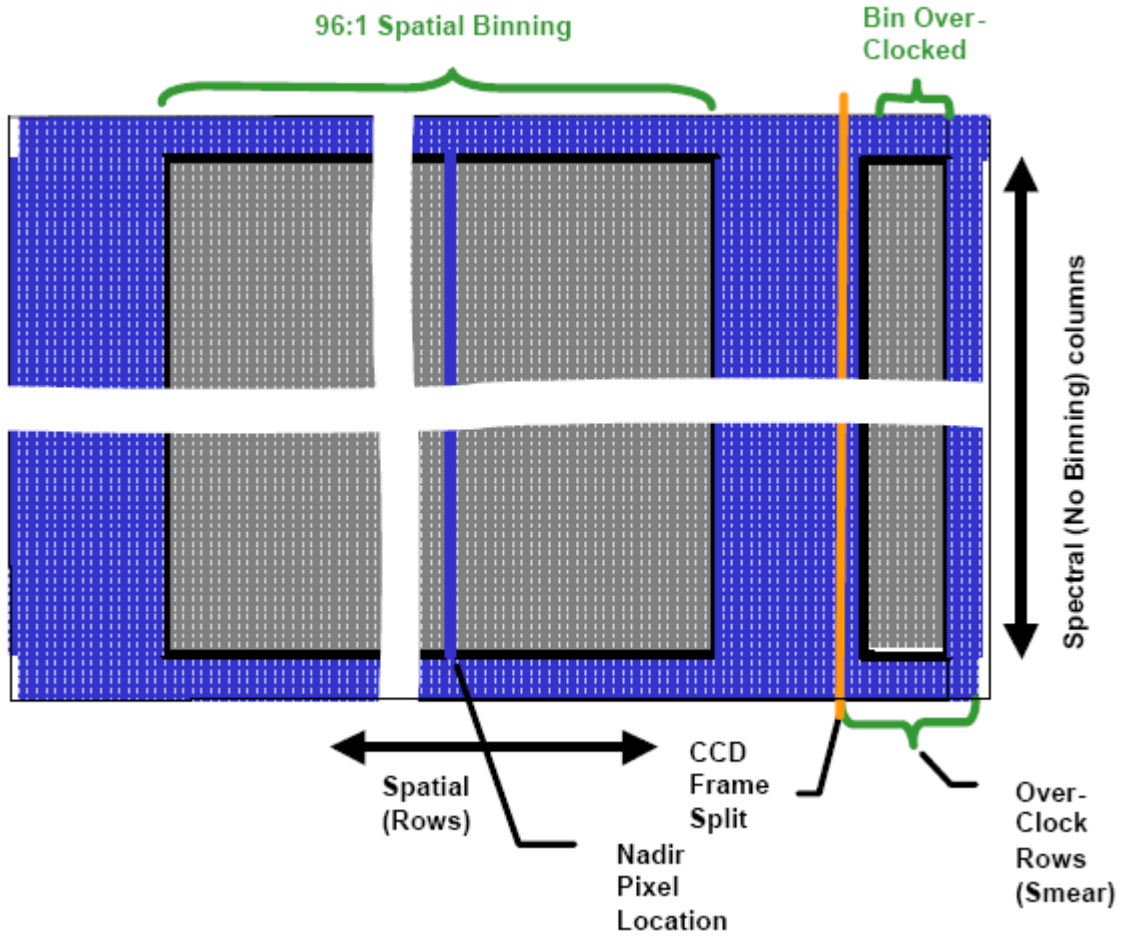

Figure 4.4.7-1, OMPS Nadir Profile On-orbit Windowing and Spatial Binning

4.4.8 Calibration – NTCC

Data Mnemonic	OM_NU-L00000-009
APID	564 NTC Calibration Data 580 Diagnostic NTC Calibration Data
Description/ Purpose	Nadir Total Column application packet containing calibration data for solar, linearity and dark current calibrations. This application packet contains OMPS and Nadir Sensor health and status telemetry followed by calibration Nadir Total Column CCD data. Solar, linearity and dark current calibrations are performed in a single orbit every week. Because the solar, linearity and dark current calibrations require different image sizes, APID 564 is a variable-sized (usually) grouped packet. The Diagnostic NTC Calibration Data packet is the corresponding diagnostic version of the science packet, used when warranted to troubleshoot anomalies. The diagnostic packet size is configurable. Its structure is the same as the operational NTC Calibration packet, although the amount of science data may vary.
Packet Size	Total Packet Size (octets): Up to 1,135,824 Typical Science Data Size (octets): 1,135,680 This packet size varies, and could possibly (though unlikely) even be standalone. The maximum packet requires multiple groups of 256 packets.
Availability	564 - Operational Mode 580 - Diagnostic Mode
Frequency	Generation Period (sec): Aperiodic Downlink Rate (Hz): Aperiodic
Data Content and Data Format	1 st packet in a group: Secondary Header Application Data - OMPS Header 2 octets: RDR Version 1 octet: Cont Count-1 (For groups of packets, this is remaining groups-1 in dump) 1 octet: Cont Flag (Beginning of RDR Flag) - Sensor ID Info: 7 octets - Engineering Data 117 octets (Only in 1 st packet of 1 st group)

- Science Data: 880 octets
- Middle & Last packets in the group:
- Application Data is Science Data: up to 1018 octets/packet

Each packet produced contains a single CCD image. During calibration orbits, the OMPS produces multiple packets of each type. Solar, linearity and dark current calibration measurements are made for each CCD. The solar images measure the spectral and radiometric response of the CCD. Each type of calibration requires multiple images of varying sizes. The quantity, size and duration of the calibration images is still being determined.

The weekly calibration of the OMPS instrument will take multiple orbits to complete. Nadir Sensor calibrations begin before the sensor would normally be turned off (t_1 in Figure 4.4.2.4-1, OMPS Time Marker Description for a Descending Orbit) Because the diffuser takes up only a portion of the total Nadir Column field of view, seven overlapping images are necessary to complete the Nadir Column radiometric/spectral calibration. The Nadir Profiler radiometric/spectral calibration is obtained when the diffuser is in the middle position of the seven Nadir Column images. Dark current and two linearity images for each spectrometer/CCD follow when the OMPS is in the shadow of the Earth.

4.4.9 Calibration – NPC

Data Mnemonic	OM_NU-L00000-010
APID	565 Nadir Profiler Calibration Data 581 Diagnostic Nadir Profiler Calibration Data
Description/ Purpose	Nadir Profiler application packet containing calibration data. This application packet contains OMPS and Nadir Sensor health and status telemetry followed by calibration Nadir Profiler CCD data. Solar, linearity and dark current calibrations are performed in a single orbit every week. Because the solar, linearity and dark current calibrations require different image sizes, APID 565 is a variable-sized (usually) grouped packet. The Diagnostic Nadir Profiler Calibration Data is the corresponding diagnostic version of the science packet, used when warranted to troubleshoot anomalies. The diagnostic packet size is configurable. Its structure is the same as the operational NP Calibration packet, although the amount of science data may vary.
Packet Size	Total Packet Size (octets): 567,984 Typical Science Data Size (octets): 567,840 This packet size varies, and could possibly (though unlikely) even be standalone. The maximum size packet requires multiple groups of 256 packets.
Availability	565 - Operational Mode 581 - Diagnostics Mode
Frequency	Generation Period (sec): Aperiodic Downlink Rate (Hz): Aperiodic
Data Content and Data Format	1 st packet in a group: Secondary Header Application Data - OMPS Header 2 octets: RDR Version 1 octet: Cont Count-1 (For groups of packets, this is remaining groups-1 in dump) 1 octet: Cont Flag (Beginning of RDR Flag) - Sensor ID Info: 7 octets - Engineering Data 117 octets (Only in 1 st packet of 1 st group) - Science Data: 880 octets Middle & Last packets in the group:

Application Data is Science Data: up to 1018 octets/packet

4.4.10 Health & Status Data

Data Mnemonic	OM_NU-L00000-012
APID	544 Health & Status Data
Description/ Purpose	The Health and Status Data packet contains telemetry points relevant to the health and status of the OMPS instrument. It consists of all engineering data produced by the OMPS
Packet Size	Total Packet Size (octets): 968 Typical Science Data Size (octets): No science data
Availability	Operational Mode
Frequency	Generation Period is 5 sec Downlink Rate is 0.20(Hz)
Data Content and Data Format	Secondary Header Application Data - OMPS Header 2 octets: RDR Version 1 octet: Cont Count-1 (For groups of packets, this is remaining groups-1 in dump) 1 octet: Cont Flag (Beginning of RDR Flag) - Sensor ID Info: 7 octets - Health & Status Data This includes Fault list and Nadir status data; command status/history; CBM, CSM, upload and dump statuses; various temperatures, voltages and currents; FSW and register statuses. For more details see Part 3 of this document.

4.4.11 LEO & A Housekeeping Data

Data Mnemonic	OM_NU-L00000-013
APID	545 LEO & A Housekeeping Data
Description/ Purpose	The LEO & A Housekeeping Data packet contains primary and secondary headers, and seven bytes of sensor information.
Packet Size	Total Packet Size (octets): 27 Typical Science Data Size (octets): No science data
Availability	Operational Mode
Frequency	Generation Period is 5 sec Downlink Rate is 0.20(Hz)
Data Content and Data Format	Secondary Header Application Data - OMPS Header 2 octets: RDR Version 1 octet: Cont Count-1 (For groups of packets, this is remaining groups-1 in dump) 1 octet: Cont Flag (Beginning of RDR Flag) - Sensor ID Info: 7 octets

4.4.12 Test Telemetry

Data Mnemonic	OM_NU-L00000-014
APID	546 Test Telemetry
Description/ Purpose	<p>Test Telemetry Packet used to test the spacecraft-to-OMPS interface. It is initiated and stopped by sending the TLMTEST command This command causes the FSW to produce a fixed size packet containing a fixed bit pattern at a rate of one every five seconds (0.2 Hz).</p> <p>NOTE: The test telemetry packets are created in addition all other OMPS Raw Data Records (RDRs).</p> <p>This means that test telemetry packets will be generated in addition to Health and Status RDRs and any other RDRs the FSW is commanded to produce</p>
Packet Size	Total Packet Size (octets): 6
Availability	When commanded
Frequency	Generation Period is 5 sec.
Data Content and Data Format	Primary Header only.

4.5 Clouds and the Earth's Radiant Energy System (EDFCB7-TBR-10299)

This section will be completed when the information becomes available.

4.6 Microwave Imager Sounder

The Microwave Imager Sounder (MIS) is externally provided and the definitions will be completed when the information becomes available. [EDFCB7-TBD-10508](#)

4.7 Space Environment Monitor

The Space Environment Monitor (SEM) is externally provided and the definitions will be completed when the information becomes available. [EDFCB7-TBD-10509](#)

4.8 Space Environment Sensor Suite

The Space Environment Sensor Suite (SESS) is currently demanifested.

4.9 Advanced Data Collection System

4.9.1 A-DCS Overview

The Advanced Data Collection System (A-DCS) that collects in-situ environmental and other science data from remote sensor beacons is a component of the Argos Data Collection System (DCS) international global tracking and surface data collection system. Argos is a satellite-based system able to locate fixed or mobile platforms anywhere in the world. The beacons on these platforms provide environmental data, which can be collected by satellites in various orbits. The purpose of the Argos DCS is to provide a worldwide in-situ environmental data collection and Doppler-derived location service with the objective of studying and protecting the earth environment. Remote and unmanned Data Collection Platforms (DCP) in the form of surface and sub-surface buoys, balloons, and weather stations are used for measuring environmental factors such as atmospheric temperature and pressure, and velocity and direction of the ocean waves and wind currents. The A-DCS instruments collect and process these measurements for both immediate transmission, and on-board storage for subsequent transmission, from the satellite to high latitude ground stations at each orbit.

4.9.1.1 A-DCS Function, Message Processing and Routing

The NPOESS spacecraft RF accommodation hardware receives randomly distributed uplink signals from DCPs deployed worldwide and provides these signals to the A-DCS instrument.

The A-DCS instrument provides the processed data to the NPOESS satellite and forwards but does no further processing of the observational data. Observational data [also known as mission data] as well as housekeeping data [aka instrument state-of-health telemetry], are placed into CCSDS packets (with headers) by the spacecraft flight software. CCSDS packets containing either mission data or housekeeping data now called Stored Mission Data (SMD), are recorded (i.e. stored) on the spacecraft's solid state recorders (SSR) until the next transmission to a C3S receptor site. The spacecraft transmits the SMD data to the ground via Ka-band. Mission data along with two-line

element (TLE) sets are also sent to field terminals via HRD and LRD (X-band and L-band respectively). Although mission data is included in the HRD only the LRD is used by Collecte Localisation Satellite (CLS). All uploaded directives from the sensors, corrupted or not, are included in the A-DCS mission data (SMD, LRD, and HRD).

On the ground, the C3S Data Routing and Retrieval (DRR) separates the mission data (MD) and housekeeping (HK) telemetry from the SMD by virtual channel and provides it to the NESDIS Central Interface Data Processor (IDP). The IDP Segment (IDPS) reformats it using HDF5 and calls it raw data records (RDR). The RDR (raw HK) and mission data is stored at the IDPS and made available to the NESDIS central for further processing and distribution. In the NPOESS system the stored telemetry analysis (STA) subsystem, which is part of the Mission Management Center (MMC), processes the stored telemetry in the SMD and automatically generates pre-defined reports and plots for authorized users.

4.9.1.2 A-DCS Data Type Mappings

Table 4.9.1.1-1, A-DCS Application Packet Types, presents a mapping of the A-DCS data types to the Application Packet Identifier (APID) assignments.

Table 4.9.1.2-1, A-DCS Application Packet Types

CDFCB-X Section	Data Mnemonic Data Type	APID	Packet Type	Packet Size (octets)	Frequency (packets/sec)
4.9.2 Engineering – Housekeeping	DC-NU-L00000-002	672	Housekeeping	max 65,536 min 122	Varies
4.9.3 Science – Mission data	DC-NU-L00000-001	688	Science	1953	1

4.9.2 Housekeeping

Data Mnemonic	DC_NU-L00000-002
APID	672 – Housekeeping
Description/ Purpose	<p><u>For A-DCS:</u></p> <p>HK is both analog and active bi-level digital data. The spacecraft samples telemetry points at its own schedule and does the formatting into digital words itself, sends that to FSW which will then place that into CCSDS packets. This is eventually sent to the ground beginning with the 1394 bus between the instrument and the Spacecraft Control Processor (SCP). C3S decommutates the packets per the spacecraft database, and provides the results to the IDPS and STA. The unprocessed packets are also available on the Playback Telemetry and Stored Mission Data streams.</p> <p>The analog data is converted to its digital equivalent by the s/c. The digital HK telemetry is single bit digital from A-DCS. Both are processed into 8-bit word packets and sent to the s/c as 8 bit bytes (words) in a serial data stream. These 8 bit chunks are sent to the s/c, which puts them in packets and sends these to the ground, where they are passed to the USGPC and to the STA, for reporting and notifications. All C&DH on A-DCS uses a custom interface as described below.</p> <p>1394: A-DCS has a serial interface in the Peripheral Interface Module (PIM) on the Payload Support Processor (PSP). The spacecraft FSW collects the A-DCS active bi-level telemetry (122 octets at a time), places the data into a CCSDS packet, and forwards the packet to the Data Server Unit (DSU) over the 1394 bus.</p> <p>For analog HK data, the A-DCS has a point-to-point interface to a Remote Interface Unit (RIU), which is connected to the SCP. The data from the A-DCS is read and made available for the telemetry software. The telemetry format tables, from Electronic Design Integration (EDI), collect this data, place it into CCSDS packets and send it to the S-Band Module (SBM) as well as the DSU over the 1394 bus.</p> <p>For additional information on the instrument to spacecraft interface, see IF31-0033, ICD for the Advanced Data Collection and Location System.</p>
Packet Size	Maximum 65,536; minimum 122.
Availability	As CCSDS packets are collected and built by FSW.

Frequency

As CCSDS packets are collected, built, and transmitted by FSW. Configurable between 3 and 27 minutes.

**Data Content
and Data
Format**

The message blocks begin with a 12 bit synch word, followed by a 4 bit block code identifying the block as housekeeping. See description above for more information.

4.9.3 Science – SMD

Data Mnemonic	DC_NU-L00000-001
APID	688 Science data transmitted to C3S in SMD.
Description/ Purpose	<p>CCSDS packet format: MD is digital data sent to the s/c as 8 bit octets in a serial data stream. These 8 bit word chunks are sent to the spacecraft, which puts them in packets then sends this to the ground. NPOESS does not process this data and is not responsible for content. Therefore, no s/c or instrument ICD is necessary. [In simple terms: for mission data the data format is transparent to the spacecraft.]</p> <p>1394: A-DCS has a serial interface in the PIM on the PSP. The spacecraft FSW collects the A-DCS Mission Data TLM (122 octets at a time), puts the data into a CCSDS packet(s) and forwards the packet to the Data Server Unit over the 1394 bus. The A-DCS has a point-to-point interface to an RIU connected to the Spacecraft Control Processor. The data from the A-DCS is read and made available for the TLM software. The TLM format tables from the Electronic Design Integration collect this data, place it into a CCSDS packet and send it to the DSU over the 1394 bus.</p>
Packet Size	<p>The allocation for the Science application packet size is 1953 octets. Packet size is the total application packet size including the CCSDS header, which for this packet, a standalone packet, is 14 octets. This packet size allocation was defined by the Spacecraft Command & Data Handling Subsystem.</p> <p>The spacecraft sends down the A-DCS mission data without opening the packets. A-DCS will present packets at whatever rate they operate and C&DH will collect them at approximately 16kbps, assign an APID to the packets, and send to the IDPS via C3S.</p>
Availability	See above description
Frequency	Based on the allocation, the Science application packet is produced at a rate of one packet every one second.
Data Content and Data Format	See above description

4.10 Search and Rescue Satellite Aided Tracking

4.10.1 SARSAT System Overview

Distress Data

The Search and Rescue Satellite Aided Tracking (SARSAT) payload supports the global Search and Rescue (SAR) mission as part of the international Cospas-Sarsat system. (Note: COSPAS is a Russian acronym for “Cosmicheskaya Sistyema Poiska Avariynich Sudov” which means “Space System for the Search of Vessels in Distress.”) The payload will receive distress signals from 406 MHz distress beacons carried by ships (Emergency Position Indicating Radio Beacons (EPIRBs)), airplanes (Emergency Locator Transmitters (ELTs)), or individuals (Personal Locator Beacons (PLBs)) from the ground/sea/air-based beacons/transmitters and rebroadcast the data to Cospas-Sarsat ground stations in either a local mode through the Search and Rescue Repeater (SARR) or in a global mode from data stored in the Search and Rescue Processor (SARP-3). The SAR payload consists of the SARR and the SARP-3. Together, the SARR and SARP-3 are the primary instruments of the Cospas-Sarsat space segment.

A Mission Control Center (MCC) serves as the hub of information sent by the Cospas-Sarsat system. The main function of an MCC is to collect, store, and sort alert data from Local User Terminals (LUTs) and other countries' MCCs, and to distribute alert data to Rescue Co-ordination Centers (RCCs), SAR Points of Contact (SPOCS), and other MCCs.

Other Data

Besides the relayed EPIRB/ELT/PLB [distress beacon signals] data, the SARSAT global system needs additional data from the NPOESS program, beginning with the SARSAT transponder maintenance/status (aka housekeeping) telemetry from both the SARR and SARP-3. This telemetry will be encrypted on the spacecraft by Command and Data Handling (C&DH) and sent in the real-time telemetry (aka housekeeping, state of health) when passing over the Telemetry, Tracking and

Command (TT&C) site at Svalbard, Norway. It is also simultaneously sent to the solid state recorder (becoming stored telemetry), later to be sent to the receptor sites as Stored Mission Data (SMD). This SMD data is sent out first, followed by any real-time (RT) telemetry. The Command, Control and Communications Segment (C3S)/Data Routing and Retrieval (DRR) subsystem/ Data Handling Node (DHN) component strips the SARSAT telemetry by Virtual Channel Identifier (VCID), decrypts when necessary, and passes the unencrypted SMD to the Interface Data Processors (IDPs).

During Selective Data Encryption (SDE) mode the NPOESS SMD data will be encrypted in the broadcast downlink. However, the SARSAT emergency response data will never be encrypted, even during SDE. The housekeeping telemetry will always be encrypted.

4.10.1.1 SARSAT Antenna Function

The Common Receive Antenna (CRA) is a helical antenna that receives signals from the 406 MHz beacons and feeds them to the SARR and SARP.

4.10.1.2 SARP-3 Instrument Function

The SARP-3 receives, processes, and stores the beacon uplink messages. The data is stored in memory and simultaneously transmitted at 2400 bits per second to the SARR which passes it to the ground LUTs. The LUTs calculate the location from this data.

The SARP-3 instruments on SARSAT satellites do not use an onboard absolute time clock. The absolute time tagging may be calculated by the ground stations using the on-board relative time scale and the time calibration (TCAL) routinely provided by the COSPAS–SARSAT FMCC.

See ICD IF31-0053 for a description of the SARP-3's modes and operational procedures for mode transitions.

4.10.1.3 SARR Instrument Function

The SARR receives the distress signals transmitted by activated beacons and retransmits on the 1544.5 MHz downlink (L-Band) to the LUTs within the broadcast footprint of the satellite. In the LUT, for the distress beacon signals received via their respective SARR channel, each transmission is detected and the Doppler information calculated. A beacon position is then determined using this data.

Assumptions, Constraints and Notes

SARP-3 has a custom interface to the spacecraft, as explained in Section 4.10.2. SARP-3 data is routed from spacecraft processors to the DSU and S-Band module using the 1394 Bus. SARR data uses the 1553 Bus, which is converted to 1394 in FSW on the spacecraft. The SARP-3 does not send any science data through the spacecraft.

External data such as: dump, diagnostic, calibration, and dwell are not available from the SARP-3 or SARR.

A data base will be maintained for each instrument. Instrument parameters and limit values shall be supplied by CNES where required.

During Selective Data Encryption (SDE) mode the NPOESS sensor data will be encrypted in the broadcast downlink. However, the SARSAT emergency response data will never be encrypted, even during SDE. Since the telemetry encryption on-board the spacecraft is handled on a virtual channel basis, this restriction does not apply to the housekeeping telemetry from the SARSAT payload. The housekeeping telemetry will always be encrypted.

4.10.1.4 SARSAT Data Type Mappings

Table 4.10.1.4 1, SARSAT Data Type Mapping and Attributes, presents a mapping of the SARSAT data types to the APID assignments.

Table 4.10.1.4-1, SARSAT Data Type Mapping and Attributes

CDFCB-X Section	Data Mnemonic Data Type	APID	Packet Type	Sender	Receiver	Packet Size (octets)	Frequency (packets/sec)
4.10.2 Telemetry – SARP & SARR	SA-NU-L00000-001	736	SARP Telemetry	SARP	C3S	See Section 4.10.2	Varies
		704	SARR Telemetry	SARR	C3S	See Section 4.10.2	Varies

4.10.2 Telemetry – SARR and SARP

Data Mnemonic SA_NU-L00000-001

APID 736 SARP to C3S HK

704 SARR to C3S HK

Housekeeping [contains transponder and maintenance/status. This telemetry will be integrated into the RT-Tlm and SMD streams and downlinked.] This is HK from both the SARR and SARP-3. The data is packaged into CCSDS format by the FSW on-board the spacecraft.

**Description/
Purpose**

For SARP-3:

HK is both analog and active bi-level (formerly called digital B telemetry) digital data. The spacecraft samples telemetry points at its own schedule and does the formatting into digital words, sends to FSW which places data into CCSDS packets. This is eventually sent to the ground beginning with the 1394 bus, which interfaces to the Spacecraft Control Processor (SCP). C3S decommutates the packets and provides the results to the IDPS and STA.

The analog data is converted to its digital equivalent by the s/c. The digital HK telemetry is single bit digital from SARP-3. Both are processed into 8-bit word packets and sent to the s/c as 8 bit octets (words) in a serial data stream. These 8 bit chunks are sent to the s/c, which puts them in packets then sends this to the ground, to the USGPC and to the Stored Telemetry Analysis (STA), for reporting and notifications. (The stream is decommutated for stored tlm (and playback) by the STA using ECLIPSE). Therefore, no spacecraft or instrument ICD is necessary to define how the 8 bit chunks are arranged.

All C&DH on SARP-3 uses a custom interface as described below.

1394: The SARP-3 has a serial interface in the Peripheral Interface Module on the Payload Support Processor. The spacecraft FSW collects the SARP-3 active bi-level telemetry (122 octets at a time), places the data into a CCSDS packet, and forwards the packet to the Data Server Unit (DSU) over the 1394 bus.

For analog HK data, the SARP-3 has a point-to-point interface to the RIU, which is connected to the Spacecraft Control Processor (SCP). The data from the SARP-3 is read and made available for the telemetry software. The telemetry format tables, from

Electronic Design Integration (EDI), collect this data, place it into CCSDS packets and send it to the S-Band Module (SBM) as well as the DSU over the 1394 bus.

For SARR:

The SARR uses a 1553 interface to spacecraft bus.

The SARR generates CCSDS packets for its housekeeping data in accordance with the 1553 IRD; D34470. FSW places a time stamp into the packets for them. The time placed into the packets reflects the time the spacecraft receives and processes the packets.

Packet Size	SARP - 128 octets SARR - 128 octets
Availability	See Description above.
Frequency	See Description above.
Data Content and Data Format	SARP - See Description above. SARR packets do not contain a secondary header. The standalone packets contain 122 octets of application data. These consist of 61 16 bit words giving instrument temperatures, voltages, gains, currents, and various status bits.

5.0 Mission Support Data

The set of data used by the Field Terminals in conjunction with Mission Data to produce data products, and other data used to support the mission is defined as Mission Support Data (MSD). Normal components of MSD include ancillary data and auxiliary data.

Ancillary data is data that is produced externally to the NPOESS system, but is required for NPOESS data product generation. Auxiliary data is produced within the NPOESS system but is not contained in sensor application packets. MSD also encompasses data required to support the system, but is not required for product generation. Examples of Support Data are AES keys and system status bulletins (Direct Mode Data Messages).

Mission Support Data is downlinked in the APs shown below in Table 5.0-1, MSD Application Packet Types. It includes the application packets as shown in Table 5.1-1, Mission Support Data Application Packets.

Table 5.0-1, MSD Application Packet Types

CDFCB-X Section	Data Mnemonic	APID	Packet Type	Generation Mode	Packet Size (octets)	Packet Frequency (packets/sec)
5.1 Ancillary Data – Geographic Distribution	DP_NU-L00000-001	1474	MSD	Operational	See Section 5.1	0.033
5.2 MSD – Global Distribution	DP_NU-L00000-002	1475 1476	MSD	Operational	See Section 5.2	0.033
5.3 Two Line Element Sets	DP_NU-L00000-003	1473	MSD	Operational	880	0.033
5.4 Direct Mode Data Message	DP_NU-L00000-004	1472	MSD	Operational	See Section 5.4	0.033
5.5 Key Type 2 (AES2)	DP_NU-L00000-005	2030	MSD	Operational	102,960	.008
5.6 Spacecraft Digital Signature	DP_NU-L00000-006	2029	MSD	Operational	214	.008
5.7 Key Agreement	DP_NU-L00000-007	2031	MSD	Operational	214	.008

5.1 Ancillary Data – Geographic Distribution

Data Mnemonic	DP_NU-L00000-001
APID	1474 Ancillary Data – Geographic Distribution (Geographically Constrained ODAD)
Description/ Purpose	<p>The Ancillary Data – Geographic Distribution is also referred to as Geographically Constrained Official Dynamic Ancillary Data (ODAD.) This application packet contains data that is specific to a region of Spacecraft over flight. This is externally generated data used in the support of EDR generation.</p> <p>There are five (5) GcDADu tables. Each table contains data for one orbit. Each table contains up to 250 entries. The command to execute the GcDADu table will contain the table start address.</p> <p>The application packet contains 2 rows of the table of ancillary data that is most applicable to the region over which the satellite is broadcasting.</p>
Packet Size	The Ancillary Data – Geographic Distribution application packet size is approximately 2500 octets after compression. Before compression the size is 4506 octets; this includes 14 bytes of CCSDS headers, 4 bytes giving latitude /longitude; and 4488 bytes of compressed ODAD data..
Availability	The Ancillary Data – Geographic Distribution application packet is available when the NPOESS satellite is in Operational Mode.
Frequency	Two Ancillary Data – Geographic Distribution application packets are broadcast every 30 seconds, each with a subset of all the Geographically Constrained ODAD. . The period may be changed by a memory load to values between 16 and 60 seconds with a resolution of 1 second
Data Content and Data Format	<p>The ODAD part of this data is losslessly compressed (~2:1 compression) prior to uplink to preserve bandwidth. Because this is a priority packet, fill data (zeroes) is added on the ground after compression to assure a packet size that is modulo 880.</p> <p>This packet is prepared on the ground, uplinked and forwarded without change by the spacecraft to the Field Terminals.</p> <p>The data is Big Endian, and includes:</p> <ul style="list-style-type: none">Latitude: 16 bits unsigned intLongitude: 16 bits unsigned intCompressed ODAD subset: 8 bit unsigned charactersFill Bytes: as needed

The data content, data types, compression and segmentation are further described in CDFCB-X Volume VI - Ancillary Data, Auxiliary Data, Messages, and Reports, D34862-06.

5.2 MSD – Global Distribution

Data Mnemonic	DP_NU-L00000-002
APID	1475 MSD – Global Distribution for HRD/LRD 1476 MSD – Global Distribution for HRD
Description/ Purpose	<p>The MSD – Global Distribution application packet contains MSD that is relevant to field terminals regardless of their global location. It is also referred to as MSD - Globally Relevant.</p> <p>There are two sets of the data. The data is broken into groups to efficiently utilize bandwidth since not all HRD related data is required to for the LRD field terminals. These data sets are defined by the links the data is routed to.</p>
Packet Size	<p>The Ancillary Data – Global Distribution application data size is variable. Estimates are:</p> <p>1475: 20240 octets (estimate) 1476: 160160 octets (estimate)</p>
Availability	The Ancillary Data – Global Distribution application packet is available when the NPOESS satellite is in Operational Mode.
Frequency	The Ancillary Data – Global Distribution application packet is broadcast every 30 seconds, which represents approximately a 200 kilometer swath. Each individual broadcast contains 2600 octets.
Data Content and Data Format	These packets are preloaded on the ground, uplinked and forwarded without change by the spacecraft to the Field Terminals. The data content, data types and segmentation are described in CDFCB-X Volume VI - Ancillary Data, Auxiliary Data, Messages, and Reports, D34862-06.

5.3 Auxiliary Data – Two Line Element (TLE) Sets

Data Mnemonic	DP_NU-L00000-003
APID	1473 Two Line Element (TLE) Sets
Description/ Purpose	<p>A TLE set is a standard format of six independent orbital and epoch time elements, which together are sufficient to completely describe the size, shape, and orientation of an orbit. The TLE set includes drag terms and other terms to model the effects of higher orbit gravity terms. The data included in the packet provides a compact means of calculating NPP / NPOESS satellite predicted ephemeris.</p> <p>This data is used by field terminal users to establish acquisition angles, contact times, and orbit numbers for receiving NPP / NPOESS satellite HRD and LRD broadcasts.</p> <p>Each NPOESS Satellite will broadcast the entire set of TLEs for each satellite under the control the C3S MMC. (The NPP satellite does not provide this capability.) Since estimated post maneuver TLEs may also be included, there could be up to 6 TLEs in a packet.</p>
Packet Size	Each individual TLE is 142 octets; there may be up to 6 TLEs in a packet. However, because this is a priority packet the total packet size will be 880 octets.
Availability	TLEu data is down-linked in operational mode.
Frequency	TLEu data is periodically down-linked at a configurable interval, set to an initial period of 30 seconds; this value may be altered by a memory load.
Data Content and Data Format	Each TLE consists of two lines, each consisting of 69 bytes of character data plus and additional carriage return and line feed. Field contents and format are described in CDFCB-X Volume VI - Ancillary Data, Auxiliary Data, Messages, and Reports, D34862-06. As explained above there could be 1 to 6 TLEs per packet. Fill bits (zeroes) will be added by the ground to arrive at the 880 octet size for a priority packet.

5.4 Direct Mode Data Message

Data Mnemonic	DP_NU-L00000-004
APID	1472 Direct Mode Data Message
Description/ Purpose	<p>Direct Mode Data Message (DMDM) packets contain short text messages to be included with real-time broadcasts for notification to users of Spacecraft data status. DMDMs provide a transfer mechanism for Mission Notices generated by the C3S Mission Management Function to notify NPOESS operators and data consumers of upcoming events of which they should be aware (e.g., outages, orbital events, maneuvers, launches, etc). There will be a correlation between C3S issued mission notices and DMDMs..</p> <p>The system only issues a single DMDM at a time. Whenever a new DMDM is issued by the system, the old DMDM is overwritten. The persistence of the DMDM broadcast is configurable – nominally 72 hours.</p>
Packet Size	DMDM packet sizes vary; there is no requirement for DMDM packet size. There is an O&S operational constraint to limit the DMDM to the size in D35853, NPOESS Data Mapping, which is 2048 octets. Mission Notices contained within DMDM packets are limited to a maximum size of 2000 octets.
Availability	DMDM packets are generated and transmitted as required.
Frequency	When available, DMDM packets are broadcast every 30 seconds.
Data Content and Data Format	DMDM is comprised a single standalone application packet. It has a primary and secondary header. The data field consists of the 8 bit character data comprising a mission notice, in XML format. Each field is described in CDFCB-X Volume VI - Ancillary Data, Auxiliary Data, Messages, and Reports, D34862-06.

5.4.1 Uplink and Downlink Packetization

Because the downlinked packets are prepared on the ground, uplinked, and forwarded by the spacecraft without change, this subsection describes packet structure for both uplink and downlink.

The Direct Mode Data Message is a standalone packet. This APID is designated as a priority packet to expedite a timely downlink. For a packet to be priority it must be either precisely a modulo 880 bytes, or be more than 15 bytes less than a modulo 880 size. If the original packet is not 880, the spacecraft will append a Fill Packet immediately

following the DMDM packet to achieve the 880 size. Because the minimum number of fill bytes the spacecraft appends is 15, the ground must assure the size uplinked is not within 15 bytes of modulo 880 to prevent an extra packet from being generated. This can be done by adding the necessary 1-14 bytes as fill bytes at the end of the data to achieve an 880 size.

5.5 AES2 Key Transports

Data Mnemonic	DP_NU-L00000-005
APID	2030 - Key Type 2 (AES 2)Transports
Description	<p>The Advanced Encryption System (AES) Type 2 Key Transport is also referred to as the AES2 Key Transport. The AES2 key is used (in conjunction with the NPOESS Key Agreement key) by authorized field terminal users to decrypt the field terminal broadcast application packets when the NPOESS system is in Selective Data Encryption mode.</p>
Packet Size	<p>The Spacecraft AES2 Key Transports total packet size varies; it may be up to 102,960 octets, including all CCSDS headers and fill bits (0x0000) at the end. The data field of this packet contains up to 500 unique key transports for field terminal users, so the size of the packet varies with the number of approved users. Each user locates their key in the packet via a unique user ID, shown in the format below.</p> <p>Packet segmentation is also discussed below.</p>
Availability	The spacecraft broadcasts the key transport in Operational mode.
Frequency	The spacecraft broadcasts the key transport every two minutes. This period is configurable and may be altered by a memory load.
Data Content and Data Format	<p>The AES2 packet is created on the ground and uploaded to the spacecraft as a memory upload, stored in buffers on the spacecraft and retransmitted to the field terminals. The primary and secondary headers in the downlink contain values that were set on the ground for the memory load. The downlinked secondary header timestamp gives the creation time of the uploaded packet.</p> <p>When packets are segmented, each segment will have a primary header giving the length of that segment. Also, the first segment will have a secondary header giving the total number of packet segments in the sequence. (Header fields are described in detail in Section 2.1.2, Application Packet Field Contents.) Use of these fields, along with the individual key transport format given below, will enable the user to remove headers and parse through the data to locate the appropriate User ID field and obtain the requisite key information.</p> <p>The data field format for the AES2 Key transports is given here for a single key; packet segmentation is described following this table.</p> <p>The 204 octet format in the Application Data field is repeated up to 500 times, providing 500 unique keys; this repeating structure</p>

is:

Clear-text fields

- 2 octets: NPOESS Key Agreement Key Serial Number.
- 2 octets: NPOESS Digital Signature Key Serial Number.
- 2 octets: AES Key type
- 2 octets: AES Key Serial No.
- 2 octets: User Public Key Serial Number
- 2 octets: User ID
- 32 octets: Nonce (Random number)

Encrypted Fields

- 32 octets: Encrypted AES Key
- 128 octets: NPOESS Signature

5.5.1 Uplink and Downlink Packetization

Because the downlinked packets are prepared on the ground, uplinked, and forwarded by the spacecraft without change, this subsection describes packet structure for both uplink and downlink.

The AES2 Key Transports downlink will typically require packet segmentation. It is recommended that the entire packet size be modulo 880 bytes to expedite a timely downlink. The size of individual segments are set to assure efficient transmission, and expected to be 8000 octets. This may cause an individual key transport to span two segments. Packets smaller than this (i.e. less than 40 users' key transports) will be standalone.

To assure timely downlink the total packet size is an integral multiple of 880 octets. To that end, fill bits (0x0000) are added at the end of the last segment so that the total packet achieves this size. These bits are added on the ground before the packet is uploaded. This format is depicted in Figure 5.5-1, AES2 Transports Downlink Format. The figure shows the segmented packet containing keys for N users. The variable number of fill bits ending the last packet will depend on the number N of keys being transmitted.

First Packet Segment	Primary Hdr (6 octets)	Secondary Hdr (10 octets)	AES2 KT -user1 204 octets	AES2 KT -user2 204 octets	AES2 KT -user3 204 octets	AES2 KT -userX Beginning Bits
Mid Packet Segment	Primary Hdr (6 octets)	AES2 KT -userX+1 Ending Bits	AES2 KT -userX+2 204 octets	AES2 KT -userX+3 204 octets	AES2 KT -userX+4 204 octets	AES2 KT userXx Beginning
Mid Packet Segments	Primary Hdr (6 octets)	AES2 KT -userXx Ending Bits				
...	Primary Hdr (6 octets)					
...	Primary Hdr (6 octets)					
Last Packet Segment	Primary Hdr (6 octets)	AES2 KT user N-1 Ending Bits	AES2 KT -user N 204 octets	Fill bits (created by ground software) Variable number of bits added to make total packet size modulo 880			

Figure 5.5-1, AES2 Transports Downlink Format

5.6 Digital Signature Key Transport

Data Mnemonic	DP_NU-L00000-006
APID	2029 Digital Signature Public Key Transport
Description/ Purpose	The NPOESS Digital Signature private key is used to encrypt a message contained in the transport that has been passed through a hashing algorithm. The field terminal can use the NPOESS public key to decrypt the message, pass it through the hashing algorithm and authenticate it against the message in the transport. This provides a mechanism for verifying origin, data integrity and signatory non-repudiation.
Packet Size	The Spacecraft Digital Signature is 214 octets, including CCSDS primary and secondary headers.
Availability	The spacecraft broadcasts the key transports when in Operational mode
Frequency	The spacecraft broadcasts the Digital Signature Transport every two minutes to the Field Terminals.
Data Content and Data Format	<p>The Digital Signature Key Transport packet is created on the ground and uploaded to the spacecraft as a memory upload, stored in buffers on the spacecraft and retransmitted to the field terminals. The primary and secondary headers in the downlink contain values that were set on the ground for the memory load. The downlinked secondary header timestamp gives the creation time of the uploaded packet.</p> <p>This is a standalone packet. This APID is mapped as a priority packet. For a priority packet the total size for transmission must be modulo 880. Therefore the spacecraft appends a separate application packet, a fill packet of 666 octets, at the end of the digital signature packet.</p> <p>The 200 octet Digital Signature Transport data field format is given below:</p> <p>Clear-text fields</p> <ul style="list-style-type: none">2 octets: NPOESS Digital Signature Key Serial Number.2 octets: Updated NPOESS Digital Signature Key Serial Number2 octets: Key Type2 octets: User ID (Field is all 1's – 0xFFFF) <p>Indicates that this key transport is applicable to all active users and distinguishes the NPOESS Digital Signature Public Key Transport from the AES Key Transport</p>

64 octets: Updated NPOESS Digital Signature Key
Encrypted Field

128 octets: NPOESS Signature

This signature is generated using the old signature key

5.6.1 Uplink and Downlink Packetization

Because the downlinked packets are prepared on the ground, uplinked, and forwarded by the spacecraft without change, this subsection describes packet structure for both uplink and downlink.

The NPOESS Digital Signature Key Transport is a standalone packet. This APID is designated as a priority packet to expedite a timely downlink. For priority packets the total packet size must be modulo 880 bytes. To achieve this, the spacecraft appends a Fill Packet with the required number of bytes immediately following the digital signature packet. (This will be a Fill Packet APID within the same VCDU.)

5.7 Key Agreement Key Transport

Data Mnemonic	DP_NU-L00000-007
APID	2031 Key Agreement Public Key Transport
Description/ Purpose	<p>The Key Agreement is used in a key establishment procedure where the resultant secret keying material is a function of information contributed by both parties, so that both parties can predetermine the value of the secret keying material independently from the contributions of the other parties. NPOESS key agreement key private key and the field terminals public key are used in generating the secret keying material used in wrapping the AES key for the AES key transport. The field terminal private key and the NPOESS key agreement public key are used by the field terminal to generate the secret keying material to decrypt the AES key from the key transport.</p>
Packet Size	214 octets, including CCSDS primary and secondary headers.
Availability	The spacecraft broadcasts the key transports when in Operational mode.
Frequency	The spacecraft will broadcast the key transports every two minutes to the Field Terminals.
Data Content and Data Format	<p>The Key Agreement Key Transport packet is created on the ground and uploaded to the spacecraft as a memory upload, stored in buffers on the spacecraft and retransmitted to the field terminals. The primary and secondary headers in the downlink contain values that were set on the ground for the memory load. The downlinked secondary header timestamp gives the creation time of the uploaded packet.</p> <p>This is a standalone packet. This APID is mapped as a priority packet. For a priority packet the total size for transmission must be modulo 880. Therefore the spacecraft appends a separate application packet, a fill packet of 666 octets, at the end of the digital signature packet.</p> <p>The 200 octet Key Agreement Key Transport data field format is given below:</p> <p>Clear-text fields</p> <ul style="list-style-type: none">2 octets: NPOESS Digital Signature Key Serial Number.2 octets: NPOESS Key Agreement Public Key Serial Number2 octets: Key Type

2 octets: User ID (Field is all 1's – 0xFFFF)

Indicates that this key transport is applicable to all active users and distinguishes the NPOESS Key Agreement Public Key Transport from the AES Key Transport

64 octets: NPOESS Key Agreement Public Key

Encrypted Field

128 octets: NPOESS Signature

5.7.1 Uplink and Downlink Packetization

Because the downlinked packets are prepared on the ground, uplinked, and forwarded by the spacecraft without change, this subsection describes packet structure for both uplink and downlink.

The NPOESS Key Agreement Key Transport is a standalone packet. This APID is designated as a priority packet to expedite a timely downlink. For priority packets the total packet size must be modulo 880 bytes. To achieve this, the spacecraft appends a Fill Packet with the required number of bytes immediately following the key agreement packet. (This will be a Fill Packet APID within the same VCDU.)

Appendix A: DATA MNEMONIC TO INTERFACE MAPPING

This appendix maps logical interfaces to physical interfaces and data mnemonics.

Table A-1, Data Mnemonic to Interface Mapping

Data Mnemonic Name	Data Mnemonic	Document	Interface Mnemonic
Advanced Technology Microwave Sounder - Command Status Packet	AT_NU-L00000-001		
		D34650: NPOESS Command, Control, and Communications	T_SS_C3-L40000
		D34650: NPOESS Command, Control, and Communications	T_SS_C3-L20020
		D34650: NPOESS Command, Control, and Communications	T_SS_C3-L20030
Advanced Technology Microwave Sounder - LEO&A Packets	AT_NU-L00000-002		
		D34650: NPOESS Command, Control, and Communications	T_SS_C3-L40000
		D34650: NPOESS Command, Control, and Communications	T_SS_C3-L20010
		D34650: NPOESS Command, Control, and Communications	T_SS_C3-L20030
Advanced Technology Microwave Sounder - Calibration	AT_NU-L00000-003		
		D34650: NPOESS Command, Control, and Communications	T_SS_C3-L40000
		D34650: NPOESS Command, Control, and Communications	T_SS_C3-L42010
		D34650: NPOESS Command, Control, and Communications	T_SS_C3-L41010
		D34651: NPOESS Field Terminal ICD	X_SS_FS-LL2100
		D34651: NPOESS Field Terminal ICD	T_FS_FD-LB3000
		D34651: NPOESS Field Terminal ICD	X_SS_FS-LH2100
Advanced Technology Microwave Sounder - Diagnostic	AT_NU-L00000-004		

Data Mnemonic Name	Data Mnemonic	Document	Interface Mnemonic
		D34650: NPOESS Command, Control, and Communications	T_SS_C3-L40000
		D34650: NPOESS Command, Control, and Communications	T_SS_C3-L20020
		D34650: NPOESS Command, Control, and Communications	T_SS_C3-L42010
		D34650: NPOESS Command, Control, and Communications	T_SS_C3-L41010
		D34651: NPOESS Field Terminal ICD	X_SS_FS-LL2100
		D34651: NPOESS Field Terminal ICD	X_SS_FS-LH2100
Advanced Technology Microwave Sounder - Dwell	AT_NU-L00000-005		
		D34650: NPOESS Command, Control, and Communications	T_SS_C3-L40000
		D34650: NPOESS Command, Control, and Communications	T_SS_C3-L20030
Advanced Technology Microwave Sounder - Housekeeping Packet	AT_NU-L00000-006		
		D34650: NPOESS Command, Control, and Communications	T_SS_C3-L40000
		D34650: NPOESS Command, Control, and Communications	T_SS_C3-L20020
		D34650: NPOESS Command, Control, and Communications	T_SS_C3-L20030
Advanced Technology Microwave Sounder - Memory Dump Packet	AT_NU-L00000-007		
		D34650: NPOESS Command, Control, and Communications	T_SS_C3-L40000
		D34650: NPOESS Command, Control, and Communications	T_SS_C3-L20020
		D34650: NPOESS Command, Control, and Communications	T_SS_C3-L20030
Advanced Technology Microwave Sounder - Operational Science	AT_NU-L00000-008		

Data Mnemonic Name	Data Mnemonic	Document	Interface Mnemonic
		D34650: NPOESS Command, Control, and Communications	T_SS_C3-L42010
		D34650: NPOESS Command, Control, and Communications	T_SS_C3-L40000
		D34650: NPOESS Command, Control, and Communications	T_SS_C3-L41010
		D34651: NPOESS Field Terminal ICD	T_FS_FD-LB3000
		D34651: NPOESS Field Terminal ICD	X_SS_FS-LL2100
		D34651: NPOESS Field Terminal ICD	X_SS_FS-LH2100
Advanced Technology Microwave Sounder - Engineering Hot Calibration Temperatures	AT_NU-L00000-009		
		D34650: NPOESS Command, Control, and Communications	T_SS_C3-L42010
		D34650: NPOESS Command, Control, and Communications	T_SS_C3-L41010
		D34650: NPOESS Command, Control, and Communications	T_SS_C3-L40000
		D34651: NPOESS Field Terminal ICD	X_SS_FS-LL2100
		D34651: NPOESS Field Terminal ICD	X_SS_FS-LH2100
		D34651: NPOESS Field Terminal ICD	T_FS_FD-LB3000
Advanced Technology Microwave Sounder - Engineering	AT_NU-L00000-010		
		D34650: NPOESS Command, Control, and Communications	T_SS_C3-L41010
		D34650: NPOESS Command, Control, and Communications	T_SS_C3-L42010
		D34650: NPOESS Command, Control, and Communications	T_SS_C3-L40000
		D34651: NPOESS Field Terminal ICD	X_SS_FS-LL2100
		D34651: NPOESS Field Terminal ICD	X_SS_FS-LH2100
		D34651: NPOESS Field Terminal ICD	T_FS_FD-LB3000
Advanced Technology Microwave Sounder - Science Packet	AT_NU-L00000-011		
		D34650: NPOESS Command, Control, and Communications	T_SS_C3-L40000
		D34651: NPOESS Field Terminal ICD	X_SS_FS-LL2100

Data Mnemonic Name	Data Mnemonic	Document	Interface Mnemonic
Advanced Technology Microwave Sounder - Hardware Error Status	AT_NU-L00000-012		
		D34650: NPOESS Command, Control, and Communications	T_SS_C3-L40000
		D34650: NPOESS Command, Control, and Communications	T_SS_C3-L20020
		D34650: NPOESS Command, Control, and Communications	T_SS_C3-L20030
CrIS - Science - Earth, Deep Space & Internal Calibration Scene Packets	CR_NU-L00000-001		
		D34650: NPOESS Command, Control, and Communications	T_SS_C3-L42010
		D34650: NPOESS Command, Control, and Communications	T_SS_C3-L40000
		D34650: NPOESS Command, Control, and Communications	T_SS_C3-L41010
		D34651: NPOESS Field Terminal ICD	T_FS_FD-LB3000
		D34651: NPOESS Field Terminal ICD	X_SS_FS-LL2100
		D34651: NPOESS Field Terminal ICD	X_SS_FS-LH2100
CrIS - Science Telemetry Packets	CR_NU-L00000-002		
		D34650: NPOESS Command, Control, and Communications	T_SS_C3-L40000
		D34650: NPOESS Command, Control, and Communications	T_SS_C3-L41010
		D34650: NPOESS Command, Control, and Communications	T_SS_C3-L42010
		D34651: NPOESS Field Terminal ICD	T_FS_FD-LB3000
		D34651: NPOESS Field Terminal ICD	X_SS_FS-LH2100
		D34651: NPOESS Field Terminal ICD	X_SS_FS-LL2100
CrIS - Engineering Telemetry Packets	CR_NU-L00000-003		
		D34650: NPOESS Command, Control, and Communications	T_SS_C3-L41010

Data Mnemonic Name	Data Mnemonic	Document	Interface Mnemonic
		D34650: NPOESS Command, Control, and Communications	T_SS_C3-L40000
		D34650: NPOESS Command, Control, and Communications	T_SS_C3-L42010
		D34651: NPOESS Field Terminal ICD	T_FS_FD-LB3000
		D34651: NPOESS Field Terminal ICD	X_SS_FS-LH2100
		D34651: NPOESS Field Terminal ICD	X_SS_FS-LL2100
CrIS - Science - Low Rate Data Packets	CR_NU-L00000-004		
		D34650: NPOESS Command, Control, and Communications	T_SS_C3-L42010
		D34650: NPOESS Command, Control, and Communications	T_SS_C3-L40000
		D34650: NPOESS Command, Control, and Communications	T_SS_C3-L41010
		D34651: NPOESS Field Terminal ICD	X_SS_FS-LH2100
		D34651: NPOESS Field Terminal ICD	T_FS_FD-LB3000
		D34651: NPOESS Field Terminal ICD	X_SS_FS-LL2100
CrIS - Housekeeping Dwell Packets	CR_NU-L00000-005		
		D34650: NPOESS Command, Control, and Communications	T_SS_C3-L40000
		D34650: NPOESS Command, Control, and Communications	T_SS_C3-L20030
CrIS - Scene Selection Mirror Dwell	CR_NU-L00000-006		
		D34650: NPOESS Command, Control, and Communications	T_SS_C3-L40000
		D34650: NPOESS Command, Control, and Communications	T_SS_C3-L20030
CrIS - Interferometer Dwell	CR_NU-L00000-007		
		D34650: NPOESS Command, Control, and Communications	T_SS_C3-L40000
		D34650: NPOESS Command, Control, and Communications	T_SS_C3-L20030
CrIS - Diagnostic Packets	CR_NU-L00000-008		
		D34650: NPOESS Command, Control, and Communications	T_SS_C3-L40000
CrIS - Memory Dump Packets	CR_NU-L00000-009		

Data Mnemonic Name	Data Mnemonic	Document	Interface Mnemonic
		D34650: NPOESS Command, Control, and Communications	T_SS_C3-L40000
		D34650: NPOESS Command, Control, and Communications	T_SS_C3-L20020
		D34650: NPOESS Command, Control, and Communications	T_SS_C3-L20030
CrIS Instrument HK Telemetry Sub-Packet	CR_NU-L00000-010		
		D34650: NPOESS Command, Control, and Communications	T_SS_C3-L40000
		D34650: NPOESS Command, Control, and Communications	T_SS_C3-L20020
		D34650: NPOESS Command, Control, and Communications	T_SS_C3-L20030
CrIS - Launch and Early Orbit Packet	CR_NU-L00000-011		
		D34650: NPOESS Command, Control, and Communications	T_SS_C3-L40000
		D34650: NPOESS Command, Control, and Communications	T_SS_C3-L20010
		D34650: NPOESS Command, Control, and Communications	T_SS_C3-L20030
Advanced Data Collection System - Science	DC_NU-L00000-001		
		D34650: NPOESS Command, Control, and Communications	T_SS_C3-L42010
		D34650: NPOESS Command, Control, and Communications	T_SS_C3-L41010
		D34650: NPOESS Command, Control, and Communications	T_SS_C3-L40000
		D34651: NPOESS Field Terminal ICD	T_FS_FD-LB3000
		D34651: NPOESS Field Terminal ICD	X_SS_FS-LL2100
		D34651: NPOESS Field Terminal ICD	X_SS_FS-LH2100
Advanced Data Collection System - Housekeeping	DC_NU-L00000-002		
		D34650: NPOESS Command, Control, and Communications	T_SS_C3-L40000

Data Mnemonic Name	Data Mnemonic	Document	Interface Mnemonic
		D34650: NPOESS Command, Control, and Communications	T_SS_C3-L20020
		D34650: NPOESS Command, Control, and Communications	T_SS_C3-L20030
Mission Support Data: Ancillary Data - Geographic Distribution	DP_NU-L00000-001		
		D34650: NPOESS Command, Control, and Communications	T_SS_C3-L42010
		D34650: NPOESS Command, Control, and Communications	T_SS_C3-L41010
		D34651: NPOESS Field Terminal ICD	T_FS_FD-LB3000
		D34651: NPOESS Field Terminal ICD	X_SS_FS-LL2100
		D34651: NPOESS Field Terminal ICD	X_SS_FS-LH2100
Mission Support Data: Ancillary Data - Global Distribution	DP_NU-L00000-002		
		D34650: NPOESS Command, Control, and Communications	T_SS_C3-L41010
		D34650: NPOESS Command, Control, and Communications	T_SS_C3-L42010
		D34651: NPOESS Field Terminal ICD	X_SS_FS-LL2100
		D34651: NPOESS Field Terminal ICD	X_SS_FS-LH2100
		D34651: NPOESS Field Terminal ICD	T_FS_FD-LB3000
Mission Support Data: Auxiliary Data - Two Line Element Sets	DP_NU-L00000-003		
		D34650: NPOESS Command, Control, and Communications	T_SS_C3-L42010
		D34650: NPOESS Command, Control, and Communications	T_SS_C3-L41010
		D34651: NPOESS Field Terminal ICD	T_FS_FD-LB3000
		D34651: NPOESS Field Terminal ICD	X_SS_FS-LL2100
		D34651: NPOESS Field Terminal ICD	X_SS_FS-LH2100
Mission Support Data: Direct Mode Data Message	DP_NU-L00000-004		
		D34650: NPOESS Command, Control, and Communications	T_SS_C3-L42010
		D34650: NPOESS Command, Control, and Communications	T_SS_C3-L41010
		D34651: NPOESS Field Terminal ICD	T_FS_FD-LB3000

Data Mnemonic Name	Data Mnemonic	Document	Interface Mnemonic
		D34651: NPOESS Field Terminal ICD	X_SS_FS-LH2100
		D34651: NPOESS Field Terminal ICD	X_SS_FS-LL2100
Mission Support Data: AES Key Transport	DP_NU-L00000-005		
		D34650: NPOESS Command, Control, and Communications	T_SS_C3-L41010
		D34650: NPOESS Command, Control, and Communications	T_SS_C3-L42010
		D34651: NPOESS Field Terminal ICD	X_SS_FS-LL2100
		D34651: NPOESS Field Terminal ICD	X_SS_FS-LH2100
		D34651: NPOESS Field Terminal ICD	T_FS_FD-LB3000
Mission Support Data: Spacecraft Digital Signature	DP_NU-L00000-006		
		D34650: NPOESS Command, Control, and Communications	T_SS_C3-L41010
		D34650: NPOESS Command, Control, and Communications	T_SS_C3-L42010
		D34651: NPOESS Field Terminal ICD	X_SS_FS-LL2100
		D34651: NPOESS Field Terminal ICD	X_SS_FS-LH2100
		D34651: NPOESS Field Terminal ICD	T_FS_FD-LB3000
Mission Support Data: Key Agreement	DP_NU-L00000-007		
		D34650: NPOESS Command, Control, and Communications	T_SS_C3-L42010
		D34650: NPOESS Command, Control, and Communications	T_SS_C3-L41010
		D34651: NPOESS Field Terminal ICD	T_FS_FD-LB3000
		D34651: NPOESS Field Terminal ICD	X_SS_FS-LL2100
		D34651: NPOESS Field Terminal ICD	X_SS_FS-LH2100
Ozone Mapping and Profile Suite-Dwell Packets	OM_NU-L00000-002		
		D34650: NPOESS Command, Control, and Communications	T_SS_C3-L40000
		D34650: NPOESS Command, Control, and Communications	T_SS_C3-L20030
Ozone Mapping and Profile Suite – Diagnostic FSW Bootup	OM_NU-L00000-003		

Data Mnemonic Name	Data Mnemonic	Document	Interface Mnemonic
		D34650: NPOESS Command, Control, and Communications	T_SS_C3-L40000
		D34650: NPOESS Command, Control, and Communications	T_SS_C3-L20020
		D34650: NPOESS Command, Control, and Communications	T_SS_C3-L20030
Ozone Mapping and Profile Suite - Memory Dump Packets	OM_NU-L00000-004		
		D34650: NPOESS Command, Control, and Communications	T_SS_C3-L40000
		D34650: NPOESS Command, Control, and Communications	T_SS_C3-L20020
		D34650: NPOESS Command, Control, and Communications	T_SS_C3-L20030
Ozone Mapping and Profile Suite - Nadir Total Column Science Packets	OM_NU-L00000-005		
		D34650: NPOESS Command, Control, and Communications	T_SS_C3-L41010
		D34650: NPOESS Command, Control, and Communications	T_SS_C3-L40000
		D34651: NPOESS Field Terminal ICD	T_FS_FD-LB3000
		D34651: NPOESS Field Terminal ICD	X_SS_FS-LH2100
Ozone Mapping and Profile Suite - Science-NPR Packets	OM_NU-L00000-006		
		D34650: NPOESS Command, Control, and Communications	T_SS_C3-L41010
		D34650: NPOESS Command, Control, and Communications	T_SS_C3-L40000
		D34651: NPOESS Field Terminal ICD	X_SS_FS-LH2100
		D34651: NPOESS Field Terminal ICD	T_FS_FD-LB3000
Ozone Mapping and Profile Suite - Calibration-NTCC Packets	OM_NU-L00000-009		
		D34650: NPOESS Command, Control, and Communications	T_SS_C3-L41010
		D34650: NPOESS Command, Control, and Communications	T_SS_C3-L40000
		D34651: NPOESS Field Terminal ICD	X_SS_FS-LH2100

Data Mnemonic Name	Data Mnemonic	Document	Interface Mnemonic
		D34651: NPOESS Field Terminal ICD	T_FS_FD-LB3000
Ozone Mapping and Profile Suite - Calibration-NPC Packets	OM_NU-L00000-010		
		D34650: NPOESS Command, Control, and Communications	T_SS_C3-L40000
		D34650: NPOESS Command, Control, and Communications	T_SS_C3-L41010
		D34651: NPOESS Field Terminal ICD	X_SS_FS-LH2100
		D34651: NPOESS Field Terminal ICD	T_FS_FD-LB3000
Ozone Mapping and Profile Suite-Health & Status data	OM_NU-L00000-012		
		D34650: NPOESS Command, Control, and Communications	T_SS_C3-L40000
		D34650: NPOESS Command, Control, and Communications	T_SS_C3-L20020
		D34650: NPOESS Command, Control, and Communications	T_SS_C3-L20030
Ozone Mapping and Profile Suite-LEO&A Housekeeping Data	OM_NU-L00000-013		
		D34650: NPOESS Command, Control, and Communications	T_SS_C3-L40000
		D34650: NPOESS Command, Control, and Communications	T_SS_C3-L20010
		D34650: NPOESS Command, Control, and Communications	T_SS_C3-L20030
Search and Rescue Satellite Aided Tracking - Housekeeping- SARR and SARP	SA_NU-L00000-001		
		D34650: NPOESS Command, Control, and Communications	T_SS_C3-L40000
		D34650: NPOESS Command, Control, and Communications	T_SS_C3-L20020
		D34650: NPOESS Command, Control, and Communications	T_SS_C3-L20030
CCSDS Source Packet	SS_C3-L22000-000		
		D34650: NPOESS Command, Control, and Communications	T_SS_C3-L20000

Data Mnemonic Name	Data Mnemonic	Document	Interface Mnemonic
		D34650: NPOESS Command, Control, and Communications	T_SS_C3-L20010
		D34650: NPOESS Command, Control, and Communications	T_SS_C3-L20020
		D34650: NPOESS Command, Control, and Communications	T_SS_C3-L20030
		D34651: NPOESS Field Terminal ICD	X_SS_FS-LL2100
		D34651: NPOESS Field Terminal ICD	T_FS_FD-LB3000
		D34651: NPOESS Field Terminal ICD	X_SS_FS-LH2100
		D34650: NPOESS Command, Control, and Communications	T_SS_C3-L40000
		D34650: NPOESS Command, Control, and Communications	T_SS_C3-L42010
		D34650: NPOESS Command, Control, and Communications	T_SS_C3-L41010
Multiplexing Protocol Data Unit	SS_C3-L22000-010		
		D34650: NPOESS Command, Control, and Communications	T_SS_C3-L20000
		D34650: NPOESS Command, Control, and Communications	T_SS_C3-L20030
		D34650: NPOESS Command, Control, and Communications	T_SS_C3-L42010
		D34650: NPOESS Command, Control, and Communications	T_SS_C3-L20020
		D34650: NPOESS Command, Control, and Communications	T_SS_C3-L41010
		D34650: NPOESS Command, Control, and Communications	T_SS_C3-L40000
		D34650: NPOESS Command, Control, and Communications	T_SS_C3-L20010
		D34651: NPOESS Field Terminal ICD	X_SS_FS-LH2100
		D34651: NPOESS Field Terminal ICD	X_SS_FS-LL2100
Coded Virtual Channel Data Unit	SS_C3-L22000-020		
		D34650: NPOESS Command, Control, and Communications	T_SS_C3-L41010
		D34650: NPOESS Command, Control, and Communications	T_SS_C3-L40000

Data Mnemonic Name	Data Mnemonic	Document	Interface Mnemonic
		D34650: NPOESS Command, Control, and Communications	T_SS_C3-L42010
		D34651: NPOESS Field Terminal ICD	X_SS_FS-LH2100
		D34651: NPOESS Field Terminal ICD	X_SS_FS-LL2100
Channel Access Data Unit	SS_C3-L22000-030		
		D34650: NPOESS Command, Control, and Communications	T_SS_C3-L41010
		D34650: NPOESS Command, Control, and Communications	T_SS_C3-L42010
		D34650: NPOESS Command, Control, and Communications	T_SS_C3-L20020
		D34650: NPOESS Command, Control, and Communications	T_SS_C3-L20010
		D34650: NPOESS Command, Control, and Communications	T_SS_C3-L40000
		D34650: NPOESS Command, Control, and Communications	T_SS_C3-L20000
		D34650: NPOESS Command, Control, and Communications	T_SS_C3-L20030
		D34651: NPOESS Field Terminal ICD	X_SS_FS-LL2100
		D34651: NPOESS Field Terminal ICD	X_SS_FS-LH2100
Fill CADU	SS_C3-L22000-031		
		D34650: NPOESS Command, Control, and Communications	T_SS_C3-L20020
		D34650: NPOESS Command, Control, and Communications	T_SS_C3-L20030
		D34650: NPOESS Command, Control, and Communications	T_SS_C3-L20010
		D34650: NPOESS Command, Control, and Communications	T_SS_C3-L41010
		D34650: NPOESS Command, Control, and Communications	T_SS_C3-L20000
		D34650: NPOESS Command, Control, and Communications	T_SS_C3-L42010
		D34650: NPOESS Command, Control, and Communications	T_SS_C3-L40000
		D34651: NPOESS Field Terminal ICD	X_SS_FS-LL2100
		D34651: NPOESS Field Terminal ICD	X_SS_FS-LH2100

Data Mnemonic Name	Data Mnemonic	Document	Interface Mnemonic
Marker Block CADU	SS_C3-L22000-032		
		D34650: NPOESS Command, Control, and Communications	T_SS_C3-L40000
Spacecraft SCP Auxiliary Data	SS_NU-L00000-001		
		D34650: NPOESS Command, Control, and Communications	T_SS_C3-L42010
		D34650: NPOESS Command, Control, and Communications	T_SS_C3-L40000
		D34650: NPOESS Command, Control, and Communications	T_SS_C3-L41010
		D34651: NPOESS Field Terminal ICD	T_FS_FD-LB3000
		D34651: NPOESS Field Terminal ICD	X_SS_FS-LL2100
		D34651: NPOESS Field Terminal ICD	X_SS_FS-LH2100
Spacecraft DSU Auxiliary Data	SS_NU-L00000-002		
		D34650: NPOESS Command, Control, and Communications	T_SS_C3-L42010
		D34650: NPOESS Command, Control, and Communications	T_SS_C3-L41010
		D34650: NPOESS Command, Control, and Communications	T_SS_C3-L40000
		D34651: NPOESS Field Terminal ICD	T_FS_FD-LB3000
		D34651: NPOESS Field Terminal ICD	X_SS_FS-LL2100
		D34651: NPOESS Field Terminal ICD	X_SS_FS-LH2100
Visible/Infrared Imager Radiometer Suite - High Rate Data - Science Packets	VI_NU-L00000-001		
		D34650: NPOESS Command, Control, and Communications	T_SS_C3-L41010
		D34650: NPOESS Command, Control, and Communications	T_SS_C3-L40000
		D34651: NPOESS Field Terminal ICD	X_SS_FS-LH2100
		D34651: NPOESS Field Terminal ICD	T_FS_FD-LB3000
Visible/Infrared Imager Radiometer Suite - High Rate Data - Calibration Packets	VI_NU-L00000-002		
		D34650: NPOESS Command, Control, and Communications	T_SS_C3-L40000

Data Mnemonic Name	Data Mnemonic	Document	Interface Mnemonic
		D34650: NPOESS Command, Control, and Communications	T_SS_C3-L41010
		D34650: NPOESS Command, Control, and Communications	T_SS_C3-L42010
		D34651: NPOESS Field Terminal ICD	X_SS_FS-LL2100
		D34651: NPOESS Field Terminal ICD	X_SS_FS-LH2100
		D34651: NPOESS Field Terminal ICD	T_FS_FD-LB3000
Visible/Infrared Imager Radiometer Suite - Engineering Packets	VI_NU-L00000-003		
		D34650: NPOESS Command, Control, and Communications	T_SS_C3-L42010
		D34650: NPOESS Command, Control, and Communications	T_SS_C3-L40000
		D34650: NPOESS Command, Control, and Communications	T_SS_C3-L41010
		D34651: NPOESS Field Terminal ICD	X_SS_FS-LL2100
		D34651: NPOESS Field Terminal ICD	X_SS_FS-LH2100
		D34651: NPOESS Field Terminal ICD	T_FS_FD-LB3000
Visible/Infrared Imager Radiometer Suite - Low Rate Data - Science Packets	VI_NU-L00000-004		
		D34650: NPOESS Command, Control, and Communications	T_SS_C3-L42010
		D34651: NPOESS Field Terminal ICD	X_SS_FS-LL2100
		D34651: NPOESS Field Terminal ICD	T_FS_FD-LB3000
Visible/Infrared Imager Radiometer Suite: HRD - Diagnostic Packets Calibration	VI_NU-L00000-005		
		D34650: NPOESS Command, Control, and Communications	T_SS_C3-L40000
Visible/Infrared Imager Radiometer Suite: HRD - Diagnostic Packets	VI_NU-L00000-006		
		D34650: NPOESS Command, Control, and Communications	T_SS_C3-L40000

Data Mnemonic Name	Data Mnemonic	Document	Interface Mnemonic
Visible/Infrared Imager Radiometer Suite: Health and Status and Diagnostic Dwell Telemetry Packets	VI_NU-L00000-007		
		D34650: NPOESS Command, Control, and Communications	T_SS_C3-L40000
		D34650: NPOESS Command, Control, and Communications	T_SS_C3-L20020
		D34650: NPOESS Command, Control, and Communications	T_SS_C3-L20030
Visible/Infrared Imager Radiometer Suite - Memory Dump Packets	VI_NU-L00000-008		
		D34650: NPOESS Command, Control, and Communications	T_SS_C3-L40000
		D34650: NPOESS Command, Control, and Communications	T_SS_C3-L20020
		D34650: NPOESS Command, Control, and Communications	T_SS_C3-L20030

Appendix B: DOCUMENT SPECIFIC ACRONYM LIST

This table identifies and defines acronyms unique to this ICD. All other acronyms are listed and identified in the NPOESS Program Acronym List.

Table B-1, Document-Specific Acronym List

Acronym	Definition
ACA	Azimuth Control Assembly
ARGOS	Advanced Research and Global Observation Satellite
BSA	Biaxial Scan Assembly
CAD	Command Allocation Document
CBIT	Continuous Built-In Test
CCA	Circuit Card Assembly
CCD	Charge-Coupled Device
CLS	Collecte Localisation Satellite
CTA	Command and Telemetry Assembly
CMCC	Canadian Mission Control Centre
CRA	Common Receive Antenna
CSO	Cavity Stabilized Oscillator
DA	Dynamic Alignment
DAA	Data Acquisition Assembly
DAP	Data Acquisition Processor
DMMC	Downlink Message Management Center
DNB	Day/Night Band
DND	Canadian Department of National Defense
DSP	Digital Signal Processor
DSU	Data Server Unit
ELB	Emergency Locator Beacons
ESR	Electrical Substitution Radiometer
FMCC	French Mission Control Centre
FSS	Fine Sun Sensor
FTS	Fourier Transform Spectrometer (CrIS)
GCI	Generic Channel Interface
GCI	Generic Communications Interface (TSIS)

Acronym	Definition
GDO	Gunn Diode Oscillator
HAM	Half Angle Mirror
HEPS	High Energy Particle Sensor
HRD	High Resolution Data (A-DCS)
IBIT	Initiated Built-In Test
ICA	Instrument Control Assembly
ICE	Interface Control Electronics
ICP	Instrument or ICA Control Processor
IF	Intermediate Frequency
I/O	Input/Output
LEPS	Low Energy Particle Sensor
LW	Long Wave
MAM	Mosaic Attenuation or Attenuator Mirror
MBS	Master Beacon Stations
MD	Mission Data
MEB	Main Electronics Boxes
MEPS	Medium Energy Particle Sensor
MU	Microprocessor Unit
NSS	National Search and Rescue Secretariat
OCXO	Oven Controlled Crystal Oscillator
PDS	Processed Data Stream
PLO or PLLO	Phase Lock-Loop Oscillator
PIM	Peripheral Interface Module
PLB	Personal Locator Beacons
PMT	Platform Messaging Transceivers or Platform Transmitter Terminals
PRT	Precision Resistance Thermometer
R	Resistive Heaters (TSIS)
RCC	Rescue Co-ordination Centers
RFE	Receiver Front End
RIU	Remote Interface Unit
SAI	System Argos International
SARP-3	SAR Processor
SBC	Single Board Computer
SBM	S-Band Module

Acronym	Definition
SCP	Spacecraft Control Processor
SDM	Scan Drive Mechanism
SIM	Spectral Irradiance Monitor
SLA	Search and Rescue L-Band Antenna
SMA	Sensor Module Assembly
SORCE	Solar Radiation and Climate Experiment
SPA	Signal Processing Assembly
SPS	Solar Presence Sensors
SSR	Solid State Recorder
SPOCS	SAR Points of Contact
SRA	Search and Rescue/A-DCS
SSA	Sensor Scan Assembly
SSM	Scene Selection Mirror
SuS [previously SS]	Survivability Sensor
SWMWIR	Short-Wavelength to Mid-Wavelength Infrared
T	Thermistors (TSIS)
TAD	Telemetry Allocation Document
TAOS	Technology for Autonomous Operational Survivability
TC	Total Channel
TCAL	Time Calibration
TCPL	Telemetry and Command Plan
TCPR	Telemetry and Command Procedures
TEC	Thermal Electric Coolers
TIM	Total Irradiance Monitor
TM	Analog Temp Telemetry
TPG	Timing Pattern Generator
TPS	Thermal Pointing Subsystem (TSIS)
TPS	Thermal Plasma Sensor (SESS)
TXU	Transmitter Unit
VD	Video Digitizer

APPENDIX C: MDR Schema

```
<?xml version="1.0" encoding="UTF-8"?>
<xs:schema xmlns:xs="http://www.w3.org/2001/XMLSchema" elementFormDefault="qualified"
attributeFormDefault="unqualified">
  <xs:element name="MDR">
    <xs:annotation>
      <xs:documentation>Root element for the External Application Packet Format
Database</xs:documentation>
    </xs:annotation>

    <xs:complexType>
      <xs:sequence>
        <xs:element ref="TITLE_PAGE" minOccurs="1" maxOccurs="1"/>
        <xs:element ref="RCR_PAGE" />
        <xs:element ref="ATTRIBUTE" minOccurs="0" maxOccurs="unbounded"/>
        <xs:element ref="COMMON"/>
        <xs:element ref="INSTRUMENT" maxOccurs="unbounded"/>
      </xs:sequence>
      <xs:attribute name="release" use="required">
        <xs:annotation>
          <xs:documentation>The release specified the CCB information for this
Metadata Repository</xs:documentation>
        </xs:annotation>
      </xs:attribute>
      <xs:attribute name="database" use="required">
        <xs:annotation>
          <xs:documentation>The database specifies the source file or directory
or database URL for this MDR specification</xs:documentation>
        </xs:annotation>
      </xs:attribute>
    </xs:complexType>
  </xs:element>

  <xs:element name="TITLE_PAGE">
    <xs:complexType>
      <xs:sequence>
        <xs:element name="doc_title" type="xs:string" minOccurs="1"
maxOccurs="1"/>
        <xs:element name="doc_num" type="xs:string" minOccurs="1" maxOccurs="1"/>
        <xs:element name="cage_no" type="xs:string" fixed="11982" minOccurs="1"
```

```
maxOccurs="1"/>
    <xs:element name="cdrl_number" type="xs:string" fixed="A014"
minOccurs="1" maxOccurs="1"/>
    <xs:element name="revision" type="xs:string" minOccurs="1"
maxOccurs="1"/>
  </xs:sequence>
</xs:complexType>
</xs:element>

<xs:element name="RCR_PAGE">
  <xs:complexType>
    <xs:sequence>
      <xs:element name="revision" type="xs:string" minOccurs="1"
maxOccurs="1"/>
      <xs:element name="document_date" type="xs:string" minOccurs="1"
maxOccurs="1"/>
      <xs:element name="revision_description" type="xs:string" minOccurs="1"
maxOccurs="1"/>
      <xs:element name="release_type" type="xs:string" minOccurs="1"
maxOccurs="1"/>
      <xs:element name="part_1_release_version" minOccurs="1" maxOccurs="1">
        <xs:annotation>
          <xs:documentation>Contains the associated part 1 release
version</xs:documentation>
        </xs:annotation>
      </xs:element>
    </xs:sequence>
  </xs:complexType>
</xs:element>

<xs:element name="COMMON">
  <xs:annotation>
    <xs:documentation>Defines a commonly used construct within the instrument
telemetry sections of the MDR specification</xs:documentation>
  </xs:annotation>
  <xs:complexType mixed="true">
    <xs:choice minOccurs="0" maxOccurs="unbounded">
      <xs:element ref="ATTRIBUTE" minOccurs="0" maxOccurs="unbounded">
        <xs:annotation>
          <xs:documentation>Defines non-MDR standard items within the
specification</xs:documentation>
        </xs:annotation>
      </xs:element>
    </xs:choice>
  </xs:complexType>
</xs:element>
```

```
</xs:element>
<xs:element ref="AGGREGATE" minOccurs="0" maxOccurs="unbounded">
  <xs:annotation>
    <xs:documentation>Defines a complex data type.</xs:documentation>
  </xs:annotation>
</xs:element>
<xs:element ref="COMPONENT" minOccurs="0" maxOccurs="unbounded"/>
<xs:element ref="VARIANT" minOccurs="0" maxOccurs="unbounded">
  <xs:annotation>
    <xs:documentation>Defines a construct that is dependent on another
component's value</xs:documentation>
  </xs:annotation>
</xs:element>
<xs:element ref="CONVERSION" minOccurs="0" maxOccurs="unbounded"/>
<xs:element name="CONSTANT" minOccurs="0" maxOccurs="unbounded">
  <xs:complexType>
    <xs:attribute name="name" use="required">
      <xs:annotation>
        <xs:documentation>The name of this
constant</xs:documentation>
      </xs:annotation>
    </xs:attribute>
    <xs:attribute name="value" use="required">
      <xs:annotation>
        <xs:documentation>The value of this constant. Note, can be
any valid JavaScript expression.</xs:documentation>
      </xs:annotation>
    </xs:attribute>
    <xs:attribute name="type">
      <xs:annotation>
        <xs:documentation>Constrains the value to be of this named
type.</xs:documentation>
      </xs:annotation>
    <xs:simpleType>
      <xs:restriction base="xs:string">
        <xs:enumeration value="Bits"/>
        <xs:enumeration value="UInt"/>
        <xs:enumeration value="SInt"/>
        <xs:enumeration value="Float"/>
        <xs:enumeration value="FixedPt"/>
        <xs:enumeration value="Char"/>
      </xs:restriction>
    </xs:simpleType>
  </xs:complexType>
</xs:element>
```

```

        <xs:enumeration value="Undef"/>
    </xs:restriction>
</xs:simpleType>
</xs:attribute>
</xs:complexType>
</xs:element>
</xs:choice>
</xs:complexType>
</xs:element>
<xs:element name="COMPONENT">
    <xs:annotation>
        <xs:documentation>This is the lowest level or 'primitive' type in the MDR
specification.</xs:documentation>
    </xs:annotation>
    <xs:complexType mixed="true">
        <xs:sequence>
            <xs:element name="parse-basis" minOccurs="0" maxOccurs="1"/>
            <xs:choice maxOccurs="unbounded">
                <xs:element ref="ATTRIBUTE" minOccurs="0" maxOccurs="unbounded">
                    <xs:annotation>
                        <xs:documentation>Non-MDR standard data can be added to the
specification by using this element.</xs:documentation>
                    </xs:annotation>
                </xs:element>
                <xs:element ref="CONVERSION" minOccurs="0">
                    <xs:annotation>
                        <xs:documentation>Specifies conversions (calcurves) used
with this component</xs:documentation>
                    </xs:annotation>
                </xs:element>
                <xs:element ref="REF_CONVERSION" minOccurs="0"/>
                <xs:element ref="ENUMERATIONS" minOccurs="0"/>
            </xs:choice>
        </xs:sequence>
        <xs:attribute name="name" type="xs:string" use="required">
            <xs:annotation>
                <xs:documentation>The name of this component</xs:documentation>
            </xs:annotation>
        </xs:attribute>
        <xs:attribute name="type" use="required">
            <xs:annotation>

```

```
<xs:documentation>The type of this component</xs:documentation>
</xs:annotation>
<xs:simpleType>
  <xs:restriction base="xs:string">
    <xs:enumeration value="Bits"/>
    <xs:enumeration value="UInt"/>
    <xs:enumeration value="SInt"/>
    <xs:enumeration value="Float"/>
    <xs:enumeration value="FixedPt"/>
    <xs:enumeration value="Char"/>
    <xs:enumeration value="Undef"/>
  </xs:restriction>
</xs:simpleType>
</xs:attribute>
<xs:attribute name="nbits" type="xs:string" use="required">
  <xs:annotation>
    <xs:documentation>Denotes the number of bits in this
component.</xs:documentation>
  </xs:annotation>
</xs:attribute>
<xs:attribute name="value">
  <xs:annotation>
    <xs:documentation>The default value</xs:documentation>
  </xs:annotation>
</xs:attribute>
<xs:attribute name="max">
  <xs:annotation>
    <xs:documentation>The maximum allowable value</xs:documentation>
  </xs:annotation>
</xs:attribute>
<xs:attribute name="min">
  <xs:annotation>
    <xs:documentation>The minimum allowable value</xs:documentation>
  </xs:annotation>
</xs:attribute>
<xs:attribute name="time">
  <xs:annotation>
    <xs:documentation>Does this value represent time?</xs:documentation>
  </xs:annotation>
</xs:simpleType>
```

```
<xs:restriction base="xs:string">
  <xs:enumeration value="true"/>
  <xs:enumeration value="false"/>
</xs:restriction>
</xs:simpleType>
</xs:attribute>
<xs:attribute name="pattern">
  <xs:annotation>
    <xs:documentation>Parse pattern to use to test for valid input on
Char type components.</xs:documentation>
  </xs:annotation>
</xs:attribute>
<xs:attribute name="ro">
  <xs:annotation>
    <xs:documentation>Is this value read-only?</xs:documentation>
  </xs:annotation>
  <xs:simpleType>
    <xs:restriction base="xs:string">
      <xs:enumeration value="true"/>
      <xs:enumeration value="false"/>
    </xs:restriction>
  </xs:simpleType>
</xs:attribute>
<xs:attribute name="resolution">
  <xs:annotation>
    <xs:documentation>floating point multiplier used with Fixed type
components.</xs:documentation>
  </xs:annotation>
</xs:attribute>
<xs:attribute name="units">
  <xs:annotation>
    <xs:documentation>Defines the unit type of the component (e.g. temp,
meters/sec, etc.)</xs:documentation>
  </xs:annotation>
</xs:attribute>
<xs:attribute name="pointsto">
  <xs:annotation>
    <xs:documentation>Points to the name of an aggregate that uses this
as the pointer attribute. Pins the component to that aggregate.</xs:documentation>
  </xs:annotation>
</xs:attribute>
```

```

<xs:attribute name="description">
  <xs:annotation>
    <xs:documentation>Adds a short description of the
component.</xs:documentation>
  </xs:annotation>
</xs:attribute>
<xs:attribute name="override-length">
  <xs:annotation>
    <xs:documentation>Set to true to override the length of the Char type
component, otherwise truncation will occur if the new value's length exceeds the
specification.</xs:documentation>
  </xs:annotation>
</xs:attribute>
</xs:complexType>
</xs:element>
<xs:element name="AGGREGATE">
  <xs:annotation>
    <xs:documentation>Describes complex structures</xs:documentation>
  </xs:annotation>
  <xs:complexType>
    <xs:choice maxOccurs="unbounded">
      <xs:element ref="ATTRIBUTE" minOccurs="0" maxOccurs="unbounded" />
      <xs:element name="PARAMETERS">
        <xs:annotation>
          <xs:documentation>All the parameters of the aggregate structure
are defined under parameters/</xs:documentation>
        </xs:annotation>
        <xs:complexType>
          <xs:choice minOccurs="0" maxOccurs="unbounded">
            <xs:element name="P">
              <xs:complexType>
                <xs:choice>
                  <xs:element ref="AGGREGATE" />
                  <xs:element ref="COMPONENT" />
                  <xs:element ref="REF_COMPONENT" />
                  <xs:element ref="REF_VARIANT" />
                  <xs:sequence maxOccurs="unbounded">
                    <xs:element ref="VARIANT" />
                  </xs:sequence>
                </xs:choice>
              </xs:complexType>
            </xs:element>
          </xs:choice>
        </xs:complexType>
      </xs:element>
    </xs:choice>
  </xs:complexType>
</xs:element>

```



```
        </xs:element>
      </xs:choice>
    </xs:complexType>
  </xs:element>
</xs:choice>
<xs:attribute name="name" use="required">
  <xs:annotation>
    <xs:documentation>This is the name of the
aggregate</xs:documentation>
  </xs:annotation>
</xs:attribute>
<xs:attribute name="upperbound">
  <xs:annotation>
    <xs:documentation>Defines how large this aggregate can grow
to.</xs:documentation>
  </xs:annotation>
</xs:attribute>
<xs:attribute name="pointer">
  <xs:annotation>
    <xs:documentation>This specifies the component this aggregate uses to
instantiate n records of the parameters specified</xs:documentation>
  </xs:annotation>
</xs:attribute>
<xs:attribute name="choice">
  <xs:annotation>
    <xs:documentation>Set to true if the sub components are of type
choice rather than sequence. Default is sequence.</xs:documentation>
  </xs:annotation>
</xs:attribute>
<xs:attribute name="divisor">
  <xs:annotation>
    <xs:documentation>Divides the value in this cell by the number of
records in attribute pointer</xs:documentation>
  </xs:annotation>
</xs:attribute>
</xs:complexType>
</xs:element>
<xs:element name="ELEMENT_VARIANT" />
<xs:element name="CONVERSION">
  <xs:annotation>
    <xs:documentation>Specifies a calcurve or engineering unit conversion to be
used with the parent component.</xs:documentation>
```

```

</xs:annotation>
<xs:complexType>
  <xs:sequence>
    <xs:element ref="ATTRIBUTE" minOccurs="0" maxOccurs="unbounded"/>
    <xs:element name="VARIANT" minOccurs="0" maxOccurs="unbounded">
      <xs:annotation>
        <xs:documentation>Mathematical formulas are defined within
variants, that may be dependent on other components (aka switch
mnemonics)</xs:documentation>
      </xs:annotation>
    </xs:complexType>
    <xs:choice minOccurs="0" maxOccurs="unbounded">
      <xs:element ref="ATTRIBUTE" minOccurs="0"
maxOccurs="unbounded"/>
      <xs:element name="DEPENDENCY" minOccurs="0">
        <xs:annotation>
          <xs:documentation>If specified, then this conversion
will only be applied if the component evaluates to true as specified in the
dependency.</xs:documentation>
        </xs:annotation>
      </xs:element>
      <xs:element name="math" minOccurs="0">
        <xs:annotation>
          <xs:documentation>The W3C MATHML specification for this
eu conversion.</xs:documentation>
        </xs:annotation>
      </xs:element>
    </xs:choice>
    <xs:attribute name="name" use="required">
      <xs:annotation>
        <xs:documentation>Provides a descriptive name of the
variant, when there is more than one.</xs:documentation>
      </xs:annotation>
    </xs:attribute>
  </xs:complexType>
</xs:element>
</xs:sequence>
<xs:attribute name="name">
  <xs:annotation>
    <xs:documentation>The name of the conversion</xs:documentation>
  </xs:annotation>
</xs:attribute>

```

```
</xs:complexType>
</xs:element>
<xs:element name="ATTRIBUTE">
  <xs:annotation>
    <xs:documentation>Information that is not contained in MDR specifications are
handled in this optional element</xs:documentation>
  </xs:annotation>
  <xs:complexType>
    <xs:attribute name="name" type="xs:string" use="required">
      <xs:annotation>
        <xs:documentation>This is the name of a non-standard attribute. This
allows vendors to add additional information into the specification not present in the
MDR XML Schema</xs:documentation>
      </xs:annotation>
    </xs:attribute>
    <xs:attribute name="value" use="required">
      <xs:annotation>
        <xs:documentation>This stores the value of the non standard
attribute</xs:documentation>
      </xs:annotation>
    </xs:attribute>
  </xs:complexType>
</xs:element>
<xs:element name="REF_COMPONENT">
  <xs:annotation>
    <xs:documentation>Defines a component or aggregate that is a clone of a
common component or aggregate, previously defined.</xs:documentation>
  </xs:annotation>
  <xs:complexType>
    <xs:attribute name="name" use="required">
      <xs:annotation>
        <xs:documentation>The name of the component or
aggregate.</xs:documentation>
      </xs:annotation>
    </xs:attribute>
    <xs:attribute name="ref" use="required">
      <xs:annotation>
        <xs:documentation>The name of the component or aggregate defined in
common,</xs:documentation>
      </xs:annotation>
    </xs:attribute>
    <xs:attribute name="min">
```

```
<xs:annotation>
  <xs:documentation>Overrides the min value of the referenced
component, if specified.</xs:documentation>
</xs:annotation>
</xs:attribute>
<xs:attribute name="max">
  <xs:annotation>
    <xs:documentation>Overrides the max value of the referenced
component, if specified.</xs:documentation>
  </xs:annotation>
</xs:attribute>
<xs:attribute name="value">
  <xs:annotation>
    <xs:documentation>Overrides the referenced component's value if
specified</xs:documentation>
  </xs:annotation>
</xs:attribute>
</xs:complexType>
</xs:element>
<xs:element name="REF_VARIANT">
  <xs:annotation>
    <xs:documentation>Defines a variant that is a clone of a variant already
defined within the common section of the MDR specification.</xs:documentation>
  </xs:annotation>
  <xs:complexType>
    <xs:attribute name="name" use="required"/>
    <xs:attribute name="ref" use="required"/>
  </xs:complexType>
</xs:element>
<xs:element name="DEPENDENCY">
  <xs:annotation>
    <xs:documentation>Defines the dependency on another component, that will be
evaluated before the variant it is contained within will be used.</xs:documentation>
  </xs:annotation>
  <xs:complexType>
    <xs:attribute name="name" use="required">
      <xs:annotation>
        <xs:documentation>Defines the name of the component this depends
on.</xs:documentation>
      </xs:annotation>
    </xs:attribute>
    <xs:attribute name="op" use="required">
```

```
<xs:annotation>
  <xs:documentation>Defines the operation that the named component will
be evaluated against (lt, gt, le, ge, ne, eq)</xs:documentation>
</xs:annotation>
</xs:attribute>
<xs:attribute name="value" use="required">
  <xs:annotation>
    <xs:documentation>The value tested with 'op'</xs:documentation>
  </xs:annotation>
</xs:attribute>
<xs:attribute name="ref">
  <xs:annotation>
    <xs:documentation>Denotes the name of the component, if name does not
resolve to a component in the same context as this dependency.</xs:documentation>
  </xs:annotation>
</xs:attribute>
<xs:attribute name="type">
  <xs:annotation>
    <xs:documentation>Defines whether the dependencies are or'ed or
and'ed together</xs:documentation>
  </xs:annotation>
</xs:attribute>
</xs:complexType>
</xs:element>
<xs:element name="INSTRUMENT">
  <xs:annotation>
    <xs:documentation>Defines an instrument within the MDR
specification</xs:documentation>
  </xs:annotation>
  <xs:complexType>
    <xs:choice maxOccurs="unbounded">
      <xs:element ref="ATTRIBUTE" minOccurs="0" maxOccurs="unbounded" />
      <xs:element name="DESCRIPTION" minOccurs="0">
        <xs:annotation>
          <xs:documentation>Used to add large block of descriptive
text.</xs:documentation>
        </xs:annotation>
      </xs:element>
      <xs:element ref="TELEMETRY" />
      <xs:element ref="COMMON" />
    </xs:choice>
  </xs:complexType>
</xs:element>
<xs:attribute name="name" use="required">
```

```
<xs:annotation>
  <xs:documentation>The name of this instrument</xs:documentation>
</xs:annotation>
</xs:attribute>
<xs:attribute name="schema">
  <xs:annotation>
    <xs:documentation>If an external W3C schema defines the instrument,
its filename or directory (containing the schema files) is denoted
here.</xs:documentation>
  </xs:annotation>
</xs:attribute>
</xs:complexType>
</xs:element>
<xs:element name="ENUMERATIONS">
  <xs:annotation>
    <xs:documentation>Defines a set of enumerated values a parent component can
take.</xs:documentation>
  </xs:annotation>
  <xs:complexType>
    <xs:sequence>
      <xs:element ref="ATTRIBUTE" minOccurs="0" maxOccurs="unbounded"/>
      <xs:element name="ENUM" maxOccurs="unbounded">
        <xs:complexType>
          <xs:attribute name="name" use="required">
            <xs:annotation>
              <xs:documentation>The display name of the
enumeration</xs:documentation>
            </xs:annotation>
          </xs:attribute>
          <xs:attribute name="start">
            <xs:annotation>
              <xs:documentation>Sets the lower bound of a
range</xs:documentation>
            </xs:annotation>
          </xs:attribute>
          <xs:attribute name="value">
            <xs:annotation>
              <xs:documentation>The value used in the ttc system when
this name is chosen.</xs:documentation>
            </xs:annotation>
          </xs:attribute>
          <xs:attribute name="end">
```

```
        <xs:annotation>
            <xs:documentation>Sets the upper bound of a
range</xs:documentation>
        </xs:annotation>
    </xs:attribute>
</xs:complexType>
</xs:element>
</xs:sequence>
</xs:complexType>
</xs:element>
<xs:element name="TELEMETRY">
    <xs:annotation>
        <xs:documentation>Defines the telemetry points within the
instrument.</xs:documentation>
    </xs:annotation>
    <xs:complexType>
        <xs:sequence>
            <xs:element ref="ATTRIBUTE" minOccurs="0" maxOccurs="unbounded"/>
            <xs:element ref="COMMON"/>
            <xs:element name="TELEMETRY_ITEM" minOccurs="0" maxOccurs="unbounded">
                <xs:annotation>
                    <xs:documentation>Defines an individual telemetry
point.</xs:documentation>
                </xs:annotation>
                <xs:complexType>
                    <xs:sequence maxOccurs="unbounded">
                        <xs:element ref="ATTRIBUTE" minOccurs="0"
maxOccurs="unbounded"/>
                        <xs:element ref="VARIANT"/>
                    </xs:sequence>
                    <xs:attribute name="name">
                        <xs:annotation>
                            <xs:documentation>The name of the telemetry point. Note,
specify name or mnemonic.</xs:documentation>
                        </xs:annotation>
                    </xs:attribute>
                    <xs:attribute name="mnemonic">
                        <xs:annotation>
                            <xs:documentation>The mnemonic of this telemetry item.
Note, specify either name or mnemonic.</xs:documentation>
                        </xs:annotation>
                    </xs:attribute>
                </xs:complexType>
            </xs:element>
        </xs:sequence>
    </xs:complexType>
</xs:element>
```

```
        <xs:attribute name="description">
            <xs:annotation>
                <xs:documentation>Description of the telemetry
point.</xs:documentation>
            </xs:annotation>
        </xs:attribute>
    </xs:complexType>
</xs:element>
</xs:sequence>
<xs:attribute ref="bitserial"/>
<xs:attribute ref="fixed-memory"/>
<xs:attribute ref="order"/>
<xs:attribute ref="trace"/>
<xs:attribute ref="wordsize"/>
<xs:attribute ref="precompile"/>
</xs:complexType>
</xs:element>
<xs:element name="VARIANT">
    <xs:annotation>
        <xs:documentation>Defines a variant element that can be employed within a
parent element. The variant is dependent on a component used within the same
contextual level as this variant being defined.</xs:documentation>
    </xs:annotation>
    <xs:complexType>
        <xs:sequence maxOccurs="unbounded">
            <xs:element ref="ATTRIBUTE" minOccurs="0"/>
            <xs:element ref="DEPENDENCY" minOccurs="0" maxOccurs="unbounded"/>
            <xs:element ref="AGGREGATE" minOccurs="0" maxOccurs="unbounded"/>
            <xs:element ref="COMPONENT" minOccurs="0" maxOccurs="unbounded"/>
            <xs:element ref="REF_COMPONENT" minOccurs="0" maxOccurs="unbounded"/>
            <xs:element ref="REF_VARIANT" minOccurs="0" maxOccurs="unbounded"/>
            <xs:element ref="VARIANT" minOccurs="0" maxOccurs="unbounded"/>
        </xs:sequence>
        <xs:attribute name="name">
            <xs:annotation>
                <xs:documentation>The name of this variant</xs:documentation>
            </xs:annotation>
        </xs:attribute>
        <xs:attribute name="dependson">
            <xs:annotation>
                <xs:documentation>A description of what this variant depends on, if
```



```
anything.</xs:documentation>
    </xs:annotation>
  </xs:attribute>
  <xs:attribute name="init">
    <xs:annotation>
      <xs:documentation>Set to true if this is the initial form to use on
initialization. Otherwise only a variant that resolves all dependencies will be
displayed in the XMLCommander program.</xs:documentation>
    </xs:annotation>
  </xs:attribute>
</xs:complexType>
</xs:element>
<xs:attribute name="wordsize">
  <xs:annotation>
    <xs:documentation>By default the word size of components are 32 bits. Change
this as appropriate with this attribute.</xs:documentation>
  </xs:annotation>
</xs:attribute>
<xs:attribute name="bitserial">
  <xs:annotation>
    <xs:documentation>By default, display of the output is word based. If the
output is to be viewed as serial, set to 'true'.</xs:documentation>
  </xs:annotation>
  <xs:simpleType>
    <xs:restriction base="xs:string">
      <xs:enumeration value="true"/>
      <xs:enumeration value="false"/>
    </xs:restriction>
  </xs:simpleType>
</xs:attribute>
<xs:attribute name="trace">
  <xs:annotation>
    <xs:documentation>Set to anything but 0 to see verbose output in
XMLCommander.</xs:documentation>
  </xs:annotation>
</xs:attribute>
<xs:attribute name="order">
  <xs:annotation>
    <xs:documentation>Defines the order of the memory, little-endian, big,
endian or swapped bytes.</xs:documentation>
  </xs:annotation>
  <xs:simpleType>
```

```
<xs:restriction base="xs:string">
  <xs:enumeration value="swab"/>
  <xs:enumeration value="little-endian"/>
  <xs:enumeration value="big-endian"/>
</xs:restriction>
</xs:simpleType>
</xs:attribute>
<xs:attribute name="fixed-memory">
  <xs:simpleType>
    <xs:restriction base="xs:string">
      <xs:enumeration value="true"/>
      <xs:enumeration value="false"/>
    </xs:restriction>
  </xs:simpleType>
</xs:attribute>
<xs:attribute name="nbits">
</xs:attribute>
<xs:attribute name="precompile">
  <xs:annotation>
    <xs:documentation>Set to true to have XMLCommander precompile the
specification as it is loaded</xs:documentation>
  </xs:annotation>
  <xs:simpleType>
    <xs:restriction base="xs:string">
      <xs:enumeration value="true"/>
      <xs:enumeration value="false"/>
    </xs:restriction>
  </xs:simpleType>
</xs:attribute>
<xs:element name="REF_CONVERSION">
  <xs:annotation>
    <xs:documentation>Refers to a conversion by name in a common section above
thios specification.</xs:documentation>
  </xs:annotation>
  <xs:complexType>
    <xs:attribute name="name" type="xs:string">
      <xs:annotation>
        <xs:documentation>Defines the name of the common conversion to
use.</xs:documentation>
      </xs:annotation>
    </xs:attribute>
```

```
</xs:complexType>  
</xs:element>  
</xs:schema>
```

Appendix C: XML Style Sheet

This section contains a style sheet to assist in viewing the XML files in Parts 2 – 5 of this document. The first few lines give guidance in the use of this file.

```
<?xml version='1.0' encoding='utf-8'?>
```

```
<xsl:stylesheet version="1.0" xmlns:xsl="http://www.w3.org/1999/XSL/Transform">
```

```
<!-- 20080912 This basic Style Sheet is provided only to assist in viewing XML files from  
Volume VII. It  
is not part of the NPOESS baseline.
```

To use the style sheet with the XML:

1) Edit the XML file, and copy the following line into the file

```
<?xml-stylesheet type="text/xsl" href="Vol7.xsl"?>
```

This line should be the 2nd line of the XML file, and follows the <?xml version...> line.

2) Save the XML.

3) "Drag and Drop" the XML file into a browser of your choice.

```
/-->
```

```
<xsl:output method="html"/>  
<xsl:template match="/MDR/INSTRUMENT/TELEMETRY">  
  <html>  
    <body>  
      <h2/>  
      <xsl:for-each select="TELEMETRY_ITEM">  
        <p>  
          <table border="1">  
            <tbody>  
              <tr bgColor="#11cdcd">  
                <th>Name</th>  
                <th>Value</th>  
              </tr>  
              <xsl:for-each select="ATTRIBUTE">  
                <tr>
```

```

        <td>
          <xsl:value-of select="@name"/>
        </td>
        <td>
          <xsl:call-template name="WriteAPID"/>
          <!-- <xsl:value-of select="@value"/>
          /-->
        </td>
      </tr>
    </xsl:for-each>
  </tbody>
</table>
<p> </p>
<table border="1">
  <tbody>
    <tr>
      <th>Name</th>
      <th># of bits</th>
      <th>Description </th>
      <th>Start Bit</th>
    </tr>

    <!-- Remove comment fields if you want to display COMMON
    <xsl:for-each
select="/MDR/INSTRUMENT[1]/COMMON/AGGREGATE/PARAMETERS/P/AGGREGAT
E/PARAMETERS/P/COMPONENT">
      <tr>
        <td><xsl:value-of select="@name"/></td>
        <td><xsl:value-of select="@nbits"/></td>

        <xsl:for-each
select="ATTRIBUTE[@name='description']|ATTRIBUTE[@name='start_bit']">
          <td> <xsl:value-of select="@value"/></td>
        </xsl:for-each>
      </tr>
    </xsl:for-each>

    <xsl:for-each
select="/MDR/INSTRUMENT/TELEMETRY/COMMON/AGGREGATE/PARAMETERS/P/C
OMPONENT">
      <tr>
        <td><xsl:value-of select="@name"/></td>
        <td><xsl:value-of select="@nbits"/></td>
      <xsl:for-each
select="ATTRIBUTE[@name='description']|ATTRIBUTE[@name='start_bit']">

```

```

        <td> <xsl:value-of select="@value"/></td>
      </xsl:for-each>

    </tr>
  </xsl:for-each>
</-->

  <xsl:for-each
select="VARIANT/AGGREGATE/PARAMETERS/P/COMPONENT |
VARIANT/COMPONENT">
    <tr>
      <td><xsl:value-of select="@name"/></td>
      <td><xsl:value-of select="@nbits"/></td>

      <xsl:for-each
select="ATTRIBUTE[@name='description']|ATTRIBUTE[@name='start_bit']">
        <td> <xsl:value-of select="@value"/></td>
      </xsl:for-each>

    </tr>
  </xsl:for-each>
</tbody>
</table>

</p>
<p/>
<p>

  <p>
  <p/>
</xsl:for-each>
</body>
</html>
</xsl:template>

<xsl:template name="WriteAPID">
  <xsl:variable name="num" select="last()"/>
  <xsl:variable name="cur" select="position()"/>
  <xsl:variable name="nam" select="@name"/>
  <xsl:variable name="val" select="@value"/>

  <xsl:choose>
    <xsl:when test="$nam='apid'">
      <xsl:call-template name="HexToDecimal">
        <xsl:with-param name="hexNumber" select="$val"/>
      </xsl:call-template>
    </xsl:when>
  </xsl:choose>

```

```
</xsl:when>
  <xsl:when test="$nam!='apid'">
    <xsl:value-of select="$val"/>
  </xsl:when>
</xsl:choose>
</xsl:template>

<xsl:template name="HexToDecimal">
  <xsl:param name="hexNumber" />
  <xsl:param name="decimalNumber" >0</xsl:param>
  <xsl:choose>
    <xsl:when test="$hexNumber">
      <xsl:call-template name="HexToDecimal">
        <xsl:with-param name="decimalNumber"
select="($decimalNumber*16)+number(substring-before(substring-
after('00/11/22/33/44/55/66/77/88/99/A10/B11/C12/D13/E14/F15/a10/b11/c12/d13/e14/f15/',sub
string($hexNumber,1,1)),'/'))" />
        <xsl:with-param name="hexNumber" select="substring($hexNumber,2)" />
      </xsl:call-template>
    </xsl:when>
    <xsl:otherwise>
      <xsl:value-of select="$decimalNumber"/>
    </xsl:otherwise>
  </xsl:choose>
</xsl:template>
<xsl:template name="asDecimal">
  <xsl:param name="number" />
  <xsl:choose>
    <xsl:when test="substring($number,1,2)='0x'">
      <xsl:call-template name="HexToDecimal">
        <xsl:with-param name="hexNumber" select="substring($number,3)"/>
      </xsl:call-template>
    </xsl:when>
    <xsl:otherwise>
      <xsl:value-of select="$number"/>
    </xsl:otherwise>
  </xsl:choose>
</xsl:template>
</xsl:stylesheet>
```